

ACKNOWLEDGEMENTS

I place on record my profound sense of gratitude to Prof. Manu Santhanam and Prof. Ravindra Gettu, for guiding me in my research and supervising the production of the thesis. But for their scholarly guidance and valuable suggestions, the completion of this dissertation would have been impossible.

I am greatly indebted to the present Head of Civil Engineering Department, Prof. K. Ramamurthy for his constant encouragement, support and valuable advice on research from the beginning of my research program. I also thank him for all the administrative support extended to me for carrying out this work. I am thankful to Dr. Radhakrishna G. Pillai, for his valuable suggestions during research.

I thank Prof. Murali Krishnan J. and Dr. Atul Narayan for their valuable technical advice for my research and permitting me to use the transportation laboratory facilities. I express my gratitude to Prof. Amlan Kumar Sengupta for his constant support and encouragement and technical inputs during various stages of my research.

My sincere thanks also goes to Prof. Nicolas Roussel, IFSTTAR, East Paris University, France, for his invaluable guidance and providing me an opportunity to join his team as intern, and gave access to the laboratory and research facilities.

I express my sincere thanks to Professor A. Meher Prasad, Former Head of the Department for extending all the facilities to carry out this work. I would also like to express my heartfelt thanks to Professor K. Ananthanarayanan, Former Head of the Laboratory for all

the facilities provided for the speedy completion of my work. I also thank all the faculty members of BTCM division for their encouragement.

My heart felt gratitude towards LC³ team members for their help given to me throughout the research. I gratefully acknowledge the Swiss Agency for Development and Cooperation for funding the project. I express my heartfelt thanks to BASF, for their supply of chemicals for the study.

I am gratefully indebted to all the lab staffs of BTCM Division for helping me in successfully completing all the experiments. I am also thankful to all the staff members of the Civil Engineering Department Office, Stores section and DCF for their cooperation.

I thank Cindrela, Dr. Sunitha, Sujatha, Biju, Sachin Paul, Deepak Kamde, Sundar, Rahul A.V., Rahul Mohan, Manu, Nithya, Swathy Manohar, Dyana, Aswathy, Lakshmi Prabha, Sachin, Basit, Swathi, Anusha, Anila, Vignesh, Thangadurai, Sanoop, Ramaswamy, Yuvaraj, and all my friends for their help and cooperation during my research work. I am greatly indebted to Vidya Subhash, Divya P. S., and Mrs. Raiza Sachin Paul for their help and encouragement that supported me during difficult times.

I thank my parents who have been my great source of strength, for their encouragement and support, without which it would have been a difficult task for me to complete my research successfully.

NITHYA NAIR V. G.

ABSTRACT

The reduction of clinker content in cement brought about by using mineral admixtures reduces the CO₂ emissions creating a positive environmental impact. Recently, combinations of limestone and calcined clay as replacement have shown good performance with respect to strength and durability. However, a clear understanding of the interaction of different chemical admixtures when such blends are used is required. In this study, the interaction of ternary blended cementitious systems of Cement – Calcined Clay – Limestone (55:30:15 %, called LC³) with Sulphonated Naphthalene Formaldehyde (SNF) and Polycarboxylic ether (PCE) superplasticizers was evaluated through tests on pastes and concrete.

The variation of flow time of LC³ pastes according to the type and dosage of superplasticizer at different water-to-binder ratios was analyzed using the Marsh cone test. Comparisons were made with pastes prepared with ordinary portland cement (OPC) and 30 % fly ash – 70 % OPC blend (FA30). The saturation dosages of superplasticizers for each binder were determined. LC³ had greater requirement of superplasticizer to reach saturation dosage compared to OPC and FA30. The flow time obtained from Marsh cone and mini-slump tests gave an assessment of superplasticizer required for each blend.

Rheological tests were conducted on cement paste using Brookfield HA DV II + Pro viscometer with vane geometry. The studies were done at saturation dosages of superplasticizer from the Marsh cone tests for the three binders and two water-to-binder ratios 0.35 and 0.40, respectively. The results showed that the LC³ blend exhibited different

rheology when compared to the conventional binder systems. LC³ has shear thinning behaviour at w/b ratio 0.40, whereas at 0.35 w/b LC³ showed shear thinning behaviour but not to the extent of OPC and FA30 using PCE and SNF at saturation dosage. On the other hand, OPC and FA30 exhibit shear-thinning behaviour for both 0.35 and 0.40 w/b ratios.

Higher dosages of superplasticizer were required for LC³ concrete to attain an equivalent slump level as OPC and fly ash based concretes. Results on concrete showed that it is possible to attain high initial workability using LC³ concrete but more attention is necessary to provide good slump retention. It was found that the combination of LC³-PCE proved better as opposed to LC³-SNF combination.

Keywords: LC³; superplasticizer; Marsh cone, mini-slump; rheology; compatibility.

TABLE OF CONTENTS

ACKNOWLEDGEMENTS	i
ABSTRACT.....	iii
TABLE OF CONTENTS	v
LIST OF TABLES	ix
LIST OF FIGURES	x
CHAPTER 1 INTRODUCTION.....	1
1.1 BACKGROUND OF THE STUDY	1
1.2 RESEARCH SIGNIFICANCE	4
1.3 RESEARCH OBJECTIVES	6
1.4 SCOPE OF THE STUDY	7
1.5 EXPERIMENTAL METHODOLOGY	7
1.6 THESIS LAYOUT.....	8
CHAPTER 2 LITERATURE REVIEW.....	10
2.1 INTRODUCTION.....	10
2.2 CEMENT-SUPERPLASTICIZER INTERACTIONS	12
2.2.1 Composition and chemistry of superplasticizers	12
2.2.2 Interaction of cement and superplasticizer	14
2.3 Factors affecting cement and superplasticizer compatibility	19
2.3.1 Effect of C ₃ A/SO ₃ ratio	20
2.3.2 Effect of fineness of cement	21
2.3.3 Incompatibility issues	22

2.3.4	Effect of superplasticizer on fresh and hardened properties of concrete	22
2.4	INTERACTION OF CHEMICAL AND MINERAL ADMIXTURES	23
2.4.1	Interaction of fly ash blends and superplasticizer	24
2.4.2	Interaction of limestone blends and superplasticizer	25
2.4.3	Interaction of calcined clay and superplasticizer	27
2.4.4	Interaction of limestone-metakaolin blends	30
2.5	SUMMARY OF LITERATURE AND NEED FOR THE STUDY	35
CHAPTER 3 MATERIALS USED FOR THE STUDY		37
3.1	INTRODUCTION	37
3.2	TYPES OF CEMENT USED	37
3.2.1	Ordinary portland cement	37
3.2.2	Fly ash	37
3.2.3	Limestone calcined clay cement (LC ³)	38
3.3	AGGREGATES	38
3.4	WATER	40
3.5	SUPERPLASTICIZER	41
CHAPTER 4 DETERMINATION OF SATURATION DOSAGE OF SUPERPLASTICIZER		42
4.1	INTRODUCTION	42
4.2	METHODOLOGY	43
4.2.1	Cement paste preparation	43
4.2.2	Marsh cone test	43
4.2.3	Mini-slump test	46

4.3	RESULTS AND DISCUSSIONS	47
4.4	SUMMARY	56
CHAPTER 5 DETERMINATION OF RHEOLOGICAL CHARACTERISTICS FROM PASTE STUDIES		58
5.1	INTRODUCTION.....	58
5.2	VISCOMETRIC STUDIES	58
5.3	EXPERIMENTAL DETAILS.....	62
5.3.1	Materials used.....	62
5.3.2	Test method using rotational viscometer	62
5.3.3	Issues faced during testing in coaxial cylindrical setup.....	65
5.3.4	Test method using vane shear	71
5.4	RESULTS AND DISCUSSION	73
5.5	SUMMARY	76
CHAPTER 6 LC³ – FRESH AND HARDENED CONCRETE.....		78
6.1	INTRODUCTION.....	78
6.2	EXPERIMENTAL DETAILS.....	78
6.2.1	Preparation of concrete	78
6.2.2	Mix proportions	79
6.3	RESULTS AND DISCUSSIONS	80
6.4	SUMMARY	87
CHAPTER 7 CONCLUSIONS.....		89
7.1	GENERAL CONCLUSIONS	89
7.2	SPECIFIC CONCLUSIONS.....	91

7.3	RECOMMENDATIONS FOR FURTHER STUDIES	93
	REFERENCES.....	94

LIST OF TABLES

Table 2.1 Effect of chemical structure on the properties of PCE based superplasticizer (Yamada et al. 2000).....	14
Table 3.1 Physical properties of OPC, fly ash and LC ³	38
Table 3.2 Chemical composition of cement, fly ash and LC ³	39
Table 3.3 Summary of properties of aggregates	39
Table 3.4 Properties of superplasticizer	41
Table 4.1 Summary of saturation dosage determined from Marsh cone tests	52
Table 5.1 Vane dimensions	72
Table 6.1 Tests done for determining the fresh and hardened properties of LC ³ concrete	80
Table 6.2 Summary of tests done to attain the target slump using PCE	82
Table 6.3 Summary of tests done to attain the target slump using SNF	83
Table 6.4 Summary of mix proportions used.....	84
Table 6.5 Slump retention of LC ³ concrete using PCE admixture	86
Table 6.6 Slump retention of LC ³ concrete using SNF admixture	86
Table 6.7 Summary of hardened properties using LC ³ -PCE combination	87
Table 6.8 Summary of hardened properties using LC ³ -SNF combination	87

LIST OF FIGURES

Figure 2.1 Effect of superplasticizer on the properties of concrete (Colleparidi 1998).....	11
Figure 2.2 Chemical structure of different polymers in superplasticizers (Tanaka 2003; Colleparidi 1998; Malhotra et al., 1995; Uchikawa 1994)	12
Figure 2.3 Adsorption of superplasticizers on cement grains during early hydration process (Plank et al., 2007).....	15
Figure 2.4 Mechanism of action of superplasticizers (Aitcin 1998).....	16
Figure 2.5 Schematic diagram showing the effect of superplasticizer on (a) fresh cement paste without admixture (b) fresh cement paste with SNF (c) fresh cement paste with PCE (Zhang et al., 2015).....	17
Figure 2.6 Adsorption isotherm of PCE and SNF admixtures (Zhang et al., 2015).....	18
Figure 2.7 Schematic diagram of the two layer adsorption of PCE molecules on cement grain (Zhang et al. 2015).....	19
Figure 3.1 Particle size distribution of fine aggregate (0-4.75 mm).....	40
Figure 3.2 Particle size distribution of coarse aggregate (4.75-20 mm).....	40
Figure 4.1 Marsh cone apparatus (All dimensions are in mm).....	45
Figure 4.2 Graphical representation to determine the saturation dosage (Gomes et al. 2002)	46
Figure 4.3 Mini-slump test apparatus (All dimensions are in mm)	47
Figure 4.4 Flow curve at w/b ratio 0.35 using PCE admixture.....	49
Figure 4.5 Flow curve at w/b ratio 0.40 using PCE admixture.....	50
Figure 4.6 Flow curve at w/b ratio 0.45 using PCE admixture.....	50
Figure 4.7 Flow curve at w/b ratio 0.35 using SNF admixture.....	51
Figure 4.8 Flow curve at w/b ratio 0.40 using SNF admixture.....	51

Figure 4.9 Flow curve at w/b ratio 0.45 using SNF admixture.....	52
Figure 4.10 Spread curve at w/b ratio 0.35 using PCE admixture.....	53
Figure 4.11 Spread curve at w/b ratio 0.40 using PCE admixture.....	54
Figure 4.12 Spread curve at w/b ratio 0.45 using PCE admixture.....	54
Figure 4.13 Spread curve at w/b ratio 0.35 w/b using SNF admixture.....	55
Figure 4.14 Spread curve at w/b ratio 0.40 w/b using SNF admixture.....	55
Figure 4.15 Spread curve at w/b ratio 0.45 w/b using SNF admixture.....	56
Figure 5.1 Flow curve for a Bingham fluid (Hackley and Ferraris 2001)	60
Figure 5.2 Flow curves for non-Newtonian fluid models (Hackley and Ferraris 2001)...	61
Figure 5.3 Brookfield HA DV II + Pro viscometer (Asphalt Laboratory, IITM).....	63
Figure 5.4 Details of coaxial setup (a) co-axial cylinder (b) SC4 21 – spindle (c) HT-2 sample chamber	64
Figure 5.5 Shear strain vs time (Jayasree, 2009)	64
Figure 5.6 Output data from Rheocalc software for OPC-PCE combination at saturation dosage for w/b ratio 0.40	66
Figure 5.7 Results for OPC-PCE combination without superplasticizer at 0.40 w/b ratio	66
Figure 5.8 Results for OPC-PCE combination at lower than saturation superplasticizer dosage and 0.40 w/b ratio	67
Figure 5.9 Results for OPC-PCE combination at saturation superplasticizer dosage and 0.40 w/b ratio	67
Figure 5.10 Results for OPC-PCE combination without superplasticizer dosage and 0.40 w/b ratio	68
Figure 5.11 Results for OPC-PCE combination at lower than saturation superplasticizer dosage and 0.40 w/b ratio	69

Figure 5.12 Results for OPC-PCE combination at saturation superplasticizer dosage and 0.40 w/b ratio	69
Figure 5.13 Results for OPC-PCE combination at saturation superplasticizer dosage and 0.40 w/b ratio, with reduced spindle diameter	70
Figure 5.14 Brookfield viscometer with vane test setup (Asphalt Laboratory, IITM)	72
Figure 5.15 Shear history of rheological testing with vane spindle	73
Figure 5.16 Viscosity at saturation dosages of PCE for binders at w/b ratio 0.35	74
Figure 5.17 Viscosity at saturation dosages of PCE for binders at w/c ratio 0.40	74
Figure 5.18 Viscosity at saturation dosage of SNF for binders at w/b ratio 0.35	75
Figure 5.19 Viscosity at saturation dosage of SNF for binders at w/b ratio 0.40	76
Figure 6.1 Correlating saturation dosage of PCE superplasticizer from paste studies with the finalized dosages from concrete	84
Figure 6.2 Water content and SP dosage requirement for each mix	85

CHAPTER 1

INTRODUCTION

1.1 BACKGROUND OF THE STUDY

India is one of the largest producers of cement. The demand of cement in India is expected to increase from 300 million tonnes (2011) to 600 million tonnes by 2020 (world business council for sustainable development, 2012). The global demand for cement is increasing tremendously because of the rise in population and emerging economy. In countries like India and China there is a need for the expansion of existing urban areas due to the pressure from population growth and the demand of cement is predicted to increase by double by 2050 (IEA, 2009). However, the increase in cement production has associated environmental impacts such as consumption of fossil fuels and large emissions of CO₂; 0.08 tons of carbon dioxide are emitted per ton of concrete (Gartner 2004). It is estimated that 5 - 8% of the global carbon dioxide emissions are from cement production (Hendriks et al. 2002, Huntzinger and Eatmon 2009). Out of this, 60-67% of CO₂ is released during the cement manufacture and the rest is released from the burning of fuels during the firing process and from the consumption of electricity for grinding. The rise in cement production to meet the increasing global demand can even increase the level up to 10 – 15% of total CO₂ emission (Parrott 2002, Habert et al. 2010). Therefore, the major challenge faced by the cement industry is to fulfill the demand and at the same time, reduce the environmental impact due to large scale carbon-dioxide emissions.

There are various options to reduce the CO₂ emission such as (i) increasing the efficiency of the process, (ii) use of alternate fuels such as bio-fuels and waste, (iii) reducing the clinker factor by substituting clinker with supplementary cementitious materials (SCMs) such as GGBS and fly ash. The use of supplementary cementitious materials and the use of alternative fuels are the common strategies adopted to reduce these environmental impacts. Some of the alternative fuels used mostly from mid 1980s are tires, animal residues, sewage sludges, waste oil and lumpy materials. The alternative fuels can have an influence on the clinker properties. The burning behaviour is different for different alternative fuels compared to fossil fuels. As a result, there can be changes in the temperature of the kiln which includes sintering temperature, length of the sintering zone and the cooling conditions. Clinker replacement by SCMs can reduce the CO₂ emissions from 0.81 to 0.64 kg/kg of cement (Hendriks et al. 2002, Schneider et al. 2011). The commonly used supplementary cementitious materials (SCMs) include industrial by-products such as fly ash and ground granulated blast furnace slag (GGBS). The addition of these SCMs has distinct benefits in that no additional clinkering process is involved thereby reducing the CO₂ emission. Also, the technique helps in utilizing these by products from industries which are otherwise dumped as land-fill. However, the reduction of clinker is not possible beyond a certain level of replacement with these SCMs. For fly ash, even though it is available in large quantities, the substitution level is limited to 30%. Even though, slag can substitute up to 70% of clinker, its availability is inadequate compared to the clinker production (Antoni et al. 2012, Scrivener 2014). Comparing the overall production of clinker with the total volume of SCMs produced, it is insufficient to meet the global demand. It is, therefore, necessary to identify new sources of SCMs with existing

natural resources in view of sustainability and environmental protection. One of the major limitations is the availability of such materials in large quantities. Another approach to reduce the CO₂ emission is the use of clinker free binders or geopolymers. The production of geopolymers has lower impact on global warming compared to ordinary portland cement. However, the production of concentrated sodium silicate solution, associated with the production of geopolymers can cause severe environmental impacts other than global warming. This effect can be reduced by making geopolymer concrete using fly ash or granulated blast furnace slags which requires less sodium silicate solution for activation. The major limitation that can arise in the system is that any variations in the materials such as fly ash or slag can affect the performance of geopolymers. Also, the durability and long-term performance of geopolymer concrete are not well known (Habert et al. 2011)

The presence of kaolinite in the clay is a key factor to use it as an SCM. Out of other clayey structures, kaolinite shows major loss in crystallinity when calcined at temperatures of 600 – 800 °C. Calcined clay/metakaolin has high potential for interaction with Ca(OH)₂ when mixed with cement (Fernandez et al. 2011). Studies showed that calcined clay at its saturation temperature and at 30 % replacement of cement had a high pozzolanic activity and contributed to the final strength of the material (Antoni et al. 2011). Even though the replacement of clinker with metakaolin has several advantages and better performance compared to portland cement, high grade kaolinite clays are very expensive. This is because the production of metakaolin is energy intensive and demands clay with high degree of purity (Hernandez et al. 2015).

The use of a ternary blend of limestone, calcined clay, and clinker called as Limestone Calcined Clay (LC³) with 50% clinker replacement was demonstrated as part of

collaborative research between the Laboratory of Construction Materials (LMC) at EPFL, Switzerland, and CIDEM in Cuba (Antoni, 2012). The use of a combination of limestone and calcined clay is a good choice because the availability exceeds the other SCMs (Díaz et al. 2017). The kaolinite used for the production of LC³ can be obtained from low grade clays, with kaolinite content under 60 %. In India, there is abundant amount of low-grade clays available in existing quarries which are mostly regarded as waste (Bishnoi et al. 2014). The use of low grade clays can avoid the need of new quarries. Also, the production of LC³ can be done with the existing equipment in a cement plant. Therefore, LC³ is cheaper or has similar production cost (Scrivener 2014).

High levels of substitution without compromising on strength and durability are possible for cement by calcined clay due to its highly pozzolanic nature. This type of cements is more economical and provides ecological benefits because of lower embodied energy of the blends compared to ordinary cement (Fernando et al. 2015).

1.2 RESEARCH SIGNIFICANCE

Generally, the addition of supplementary cementitious materials improves the strength and durability of the concrete. The rheology of the cementitious materials has significant influence on the hardened properties of concrete. Most of the studies showed that commonly used SCMs such as GGBS and fly ash improve both the rheological properties in the fresh state and hardened properties. These mineral admixtures are able to increase the flowability in the fresh state, densify microstructure and improves the mechanical properties. The scenario is different in the case of replacement with silica fume. Even though the strength increases significantly with the addition of silica fume, the flowability is considerably affected due to its high fineness. Also, due to much liberation of heat of

hydration, there are chances of thermal cracking in the hardened state. Similarly, it has been found that the addition of metakaolin causes an increase in the water demand due to its high fineness and narrow particle size distribution (Cassagnabère et al. 2013). Hence, often to maintain the required workability, the amount of superplasticizer dosage has to be increased (Batis et al. 2005). The rheological properties of all these cementitious materials can be controlled by mix design using appropriate chemical admixtures. The improper use of superplasticizers can result in excessive bleeding and segregation, loss in workability of concrete, rapid or slow setting, air entrainment etc. It is therefore, important to understand the interaction between cement and superplasticizer for better utilization of concrete.

It is found that the rheology of the cementitious systems in fresh state is directly related to strength and performance of concrete. Therefore, rheology is considered as one of the important factors for special concrete such as high-performance concrete and SCC. Yield stress and plastic viscosity are the two rheological parameters used for quantifying flowability. Yield stress is related to the slump of concrete and plastic viscosity is related to stickiness, placeability, pumpability, finishability and segregation in the concrete. The understanding of fresh paste rheology is considered important because it is regarded to be closely related to the development of microstructure of mortar and concrete. The mineral admixtures have a direct impact on the microstructure and rheology of the paste (Chindaprasirt et al. 2008).

LC³ is a ternary blend of OPC, limestone and calcined clay in a proportion of 55:15:30. In addition to the normal cement hydration products such as Calcium Silicate Hydrate gel (C-S-H), Calcium Hydroxide (CH, Ettringite (Aft) and Monosulphate (Afm) in the LC³ system, hemicarbonates are formed from the reaction of limestone with aluminates present

in calcined clay (Antoni et al. 2012). Since, calcined clay is produced at a temperature of 700-800 °C as compared to 1450 °C required for clinkering process, the higher substitution of clinker in LC³ results in energy saving and lower environmental impact. In order, to use LC³ cements in modern concrete such as high-performance concrete and SCC, it is important to have an understanding of its rheological characteristics. As explained earlier, the addition of metakaolin increases the superplasticizer dosage for a given workability (Paiva et al. 2012, Perlot et al. 2013). Whereas, the addition of limestone has positive influence on rheology as it decreases the flow resistance of concrete (Vikan and Justnes 2007, Vance et al. 2013). The rheology of limestone-metakaolin-OPC ternary blends is not well understood and needs further study. Therefore, in this study the compatibility of commercially available superplasticizer for LC³ systems in paste and concrete are determined.

1.3 RESEARCH OBJECTIVES

The principal objective of this study is to understand the interaction between superplasticizers and LC³ system. Also, another objective is to compare the flow characteristics of LC³ with OPC and FA30 (OPC replaced with 30% fly ash). Therefore, the primary experimental aims of the research are stated as follows:

- To determine the saturation dosage from the paste studies and compatibility of PCE and SNF superplasticizers with the cementitious blends for different w/b ratios.
- To study the rheological characteristics of LC³ blended system with PCE and SNF superplasticizers.

- To evaluate the performance of concrete mixes with LC³ at different binder content and water-to-binder ratio to attain high workability.

1.4 SCOPE OF THE STUDY

The study is limited to the following:

- Three types of binders were used in the study – OPC 53 grade cement, FA30 (70% OPC + 30% replacement by fly ash – laboratory blend) and LC³ (Limestone calcined clay cement – 50% clinker, 30% calcined clay, 15% limestone and 5% gypsum – factory produced).
- Two types of superplasticizers were used – PCE (Polycarboxylic ether – 34% solid content) and SNF (Sulphonated naphthalene formaldehyde – 44.5% solid content).
- The paste studies were done at w/b ratios of 0.35, 0.40 and 0.45. For rheological studies, it was limited to 0.35 and 0.40
- LC³ concrete studies were done based on fixed binder content and w/b ratio to attain target slump of 180 – 200 mm.

1.5 EXPERIMENTAL METHODOLOGY

- For objective 1- Saturation dosage of superplasticizers for LC³, FA30 and OPC at different water-to-binder ratios are determined using Marsh cone test and mini-slump test

- For objective 2 – Viscosity is measured from Brookfield viscometer for LC³, at different water-to-binder ratios and at saturation dosage of superplasticizers
- For objective 3 – LC³ concrete mixes are designed to obtain initial slump of 180 – 200 mm.

1.6 THESIS LAYOUT

The thesis comprises six chapters, a list of references and an appendix. A summary of the content in each chapter is provided below:

- The current chapter describes the background of the study. The research significance, objectives, scope and thesis layout are presented.
- Chapter 2 provides a critical review of literature on cement superplasticizer interaction. This chapter discusses about the general behaviour of PCE and SNF based superplasticizer with cement paste. The factors influencing the cement-admixture compatibility, interaction of supplementary cementitious materials such as fly ash, limestone, calcined clay and a combination of limestone calcined clay with these superplasticizers are also discussed. The need and significance of the study are emphasized at the end of the chapter.
- Chapter 3 presents the physical and chemical properties of the materials used for the present study.

- Chapter 4 begins with the determination of saturation dosage of superplasticizer with the Marsh cone and mini-slump tests. The experimental procedure is explained in detail. The influence of type of binders, amount and type of superplasticizer, w/b ratio in the fluidity are evaluated through Marsh cone and mini-slump test.
- Chapter 5 discusses about the rheological properties of cement pastes at saturation dosage of superplasticizer from the Marsh cone tests. The rheological assessment was done using Brookfield viscometer. The testing method, selection of spindle and protocol for testing are explained in detail.
- Chapter 6 deals with the design of LC³ concrete mixes to attain a target slump of high workability (180 – 200 mm). The workability is measured using slump tests. The conclusions from the paste studies are validated with the concrete slump tests. The hardened properties corresponding to the concrete with target slump are also determined. The extent of requirement of superplasticizer for concrete to attain the target slump from paste studies was evaluated.
- Chapter 7 presents the conclusions from the study. The recommendations for future research work are also highlighted.

CHAPTER 2

LITERATURE REVIEW

2.1 INTRODUCTION

The incorporation of superplasticizers plays a major role in the development of high performance concrete and self-compacting concretes (Rixom 1999, Mehta 2006). The use of superplasticizers enhances the placement and finishing characteristics of concrete by improving the workability and rheological properties even at low w/c ratio. The third-generation superplasticizers are capable of reducing the water content by 40 % or even more than conventional superplasticizers (Spiratos 2006, Alonso et al. 2013). This reduces the pore volume and thereby increases the compressive strength. Superplasticizers are mainly used for the following three reasons: (1) to increase workability without changing the mix composition, (2) for a given workability, the mixing water and the w/c ratio can be reduced, thereby increasing the strength and durability requirements, (3) reduce the cement and water content for a given workability in order to save cement, reduce shrinkage and thermal strains during cement hydration (Colleparidi 1998). The effect of superplasticizers on the properties of concrete is summarized in Figure 2.1.

The constituents present in cement play a major role in cement paste rheology. The strength of concrete is mainly dependent on the formation of C-S-H which forms 60-80% of the total mass of cement paste. The strength can be increased by lowering the water-to-cement ratio. However, the water added should be sufficient enough for ensuring the required workability. Due to the presence of unsaturated surface charges on cement, some of the

mixing water gets trapped within flocculated cement grains. The addition of superplasticizer releases this trapped water by deflocculating the cements grain.

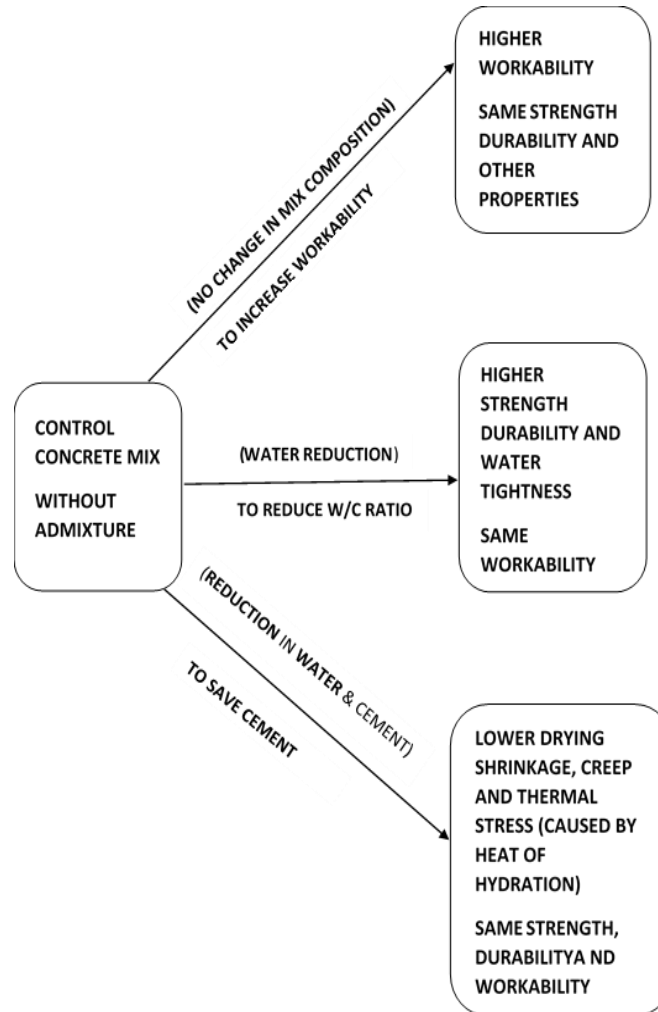

Figure 2.1 Effect of superplasticizer on the properties of concrete (Collepari 1998)

This chapter describes the influence of superplasticizers on the flow behaviour of concrete. The first part of the chapter (Sections 2.1 – 2.3) describes the role of superplasticizers in concrete production, types of superplasticizers, the interaction between cement and superplasticizer and the factors affecting the cement– superplasticizer compatibility. The

following Section 2.4 describes the interaction of mineral admixtures used for the study with superplasticizers.

2.2 CEMENT-SUPERPLASTICIZER INTERACTIONS

2.2.1 Composition and chemistry of superplasticizers

Chemical admixtures such as sulfonated melamine formaldehyde condensate (SMF), sulfonated naphthalene formaldehyde condensate (SNF) and new generation superplasticizers - polycarboxylic ether or polymethacrylates are the three commonly used superplasticizers. The chemical structures of polymers such as SNF, SMF and acrylic polymers are shown in Figure 2.2.

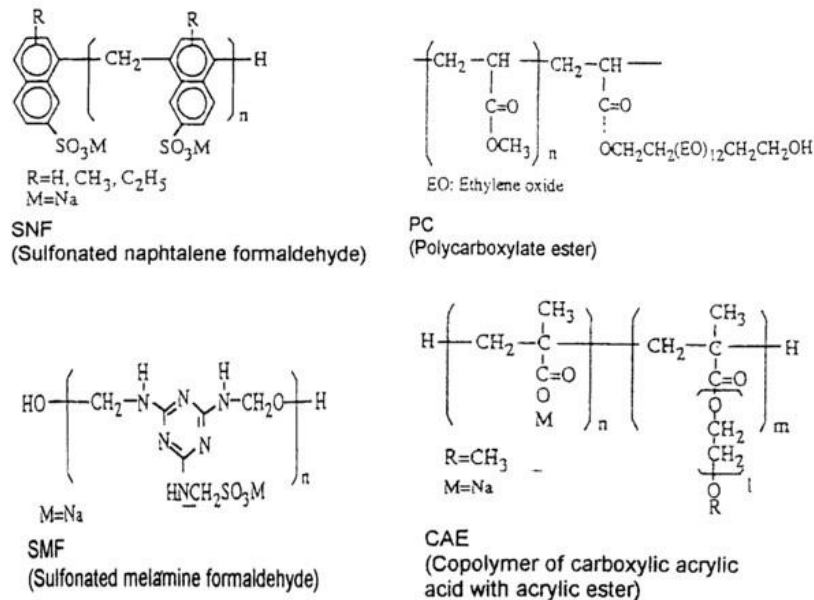

Figure 2.2 Chemical structure of different polymers in superplasticizers (Tanaka 2003; Collepari 1998; Malhotra et al., 1995; Uchikawa 1994)

SNF and SMF type superplasticizers have linear ionic organic polymers with sulphonate groups at regular intervals (Neville and Aitcin 1998). In SNF condensates, the substitution

of the hydrogen by the sulphonate can take place in two positions, namely the α and β positions due to the symmetry of the naphthalene. The β -position is thermodynamically stable compared to α -position. The dispersing effect is high for β -naphthalene sulphonic acid. Therefore, the quality and type of sulphonation is important for SNF adsorption (Piotte et al. 1995). The degree of polymerization is also another factor which affects the dispersing capability of SNF admixtures. The degree of polymerization range should be between 5 and 80 (saturation value around 10) to have the best effect. The dispersing effect is very poor when the degree of polymerization is low (less than four) and cross-linked molecules have a high molar mass. Therefore, the structural composition is also an important factor for SNFs in their dispersing abilities (Aitcin et al. 1994).

PCE admixtures are comb-shaped type of polymers with high degree of dispersing capability. Because of this reason, they are widely used in practice, approximately about two billion tons per year (Flatt et al. 2012, Gelardi et al. 2017). The addition of PCE enhances workability and improves strength and durability (Aitcin et al. 1994, Kirby et al. 2004, Houst et al. 2008). The major advantage of PCE over SNF is that the PCE molecular structure can be varied according to necessity. The performance of PCE is dependent on its molecular structure (Li et al. 2005, Gelardi et al. 2017). PCE admixtures have a main chain or backbone of carboxylic groups with non-ionic polyoxyethylene (POE) graft chains attached. The negatively charged backbone bearing carboxylic groups adsorb on the positively charged cement particles (Ohta 1997, Uchikawa et al. 1997, Yamada et al. 2000). The steric hindrance effect caused by the non-adsorbing side chains are responsible for the dispersing ability of PCEs (Ramachandran 1998, Nawa 2000, Flatt and Houst 2001).

The dispersing effect of PCE is more when the POE side chains are longer, and with lower degrees of backbone polymerization, and higher content of sulfonic groups. The setting time of cement is delayed because of high concentrations of ionic functional groups in the aqueous phase. The summary of the effect of chemical structure on the properties of PCE based superplasticizer is explained in Table 2.1. At high w/c ratios, the effect of chemical structure on paste fluidity is not significant. The effect is predominant only when the w/c ratio is below 25% (Yamada et al. 2000).

Table 2.1 Effect of chemical structure on the properties of PCE based superplasticizer (Yamada et al. 2000)

	Higher fluidity	Less fluidity loss	Shorter setting
POE chains	Longer	Shorter	Longer
Degree of polymerization of the backbone chain	Lower	-	Higher
Sulfonic group content	Higher	-	-

2.2.2 Interaction of cement and superplasticizer

The most widely used superplasticizers in concrete are sulfonated naphthalene condensates (SNF) and polycarboxylic ether (PCE) based polymers. The interaction of these superplasticizers with cement is different because of the difference in molecular structure as mentioned in the previous section. The adsorption of polymers on the cement grains during hydration process is illustrated in Figure 2.3.

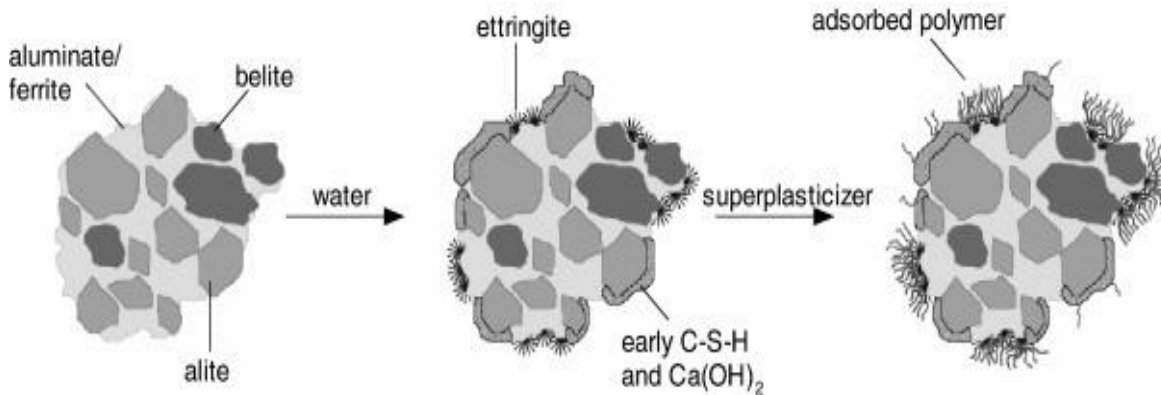

Figure 2.3 Adsorption of superplasticizers on cement grains during early hydration process (Plank et al., 2007)

The dispersion mechanisms of SNF and PCE dispersants are discussed separately. In the case of SNF, the adsorption of the SNF anionic polymers imparts a net negative electrical charge to the surface of cement particles. As a result, the repelling forces between neighboring particles i.e. electrostatic repulsion (Figure 2.4) increases, which increases the dispersion (Uchikawa et al. 1997, Kim et al. 2000, Anagnostopoulos et al. 2014). One of the limitations of using SNF is that their adsorption depends on the amount of alkali content present in the system. SNF admixtures are generally incompatible with low alkali cement. However, the situation can be improved by the presence of significant amount of residual sulphate in SNF (Kim et al. 2000).

PCE admixture as explained earlier has a linear hydrocarbon backbone chain with carboxylate and ether groups as side chains. The presence of long ether group chains generates steric repulsion which causes cement dispersion. PCE admixtures with high molecular weight, lower side chain density and shorter side chains have more adsorption on the cement grains (Zhang et al. 2015).

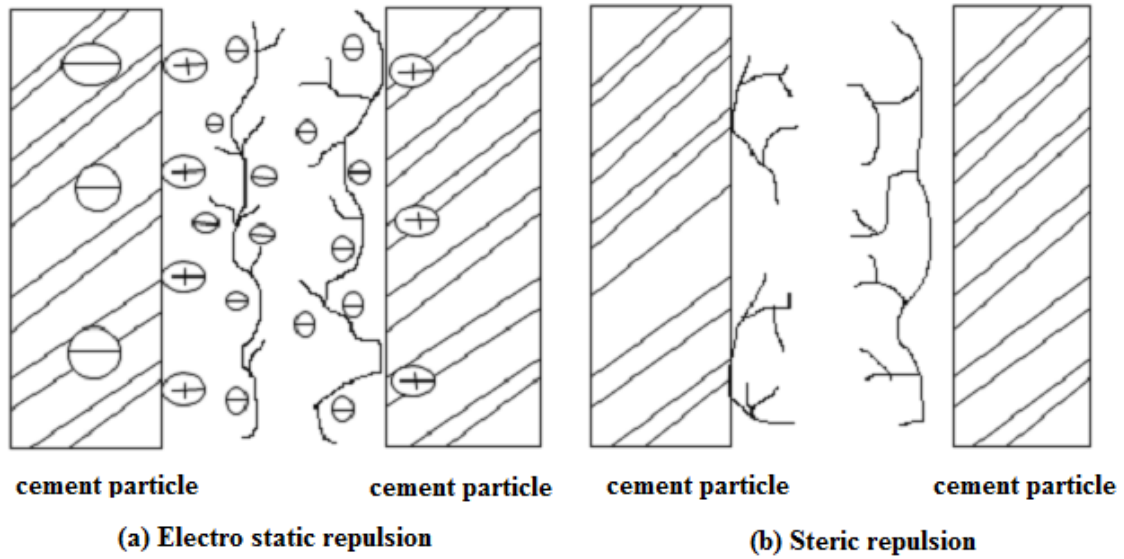

Figure 2.4 Mechanism of action of superplasticizers (Aitcin 1998)

Compared to other admixtures, PCE admixtures are more intensely adsorbed and lower the yield stress at lower dosages (Burgos-Montes et al. 2012). The reasoning is because of the combined effect of steric hindrance and electrostatic repulsion mechanism exhibited by PCE admixture (Figure 2.4). The adsorption of admixtures on cement pastes will be more if the percentage of carboxylate groups in the admixture is high. Figure 2.5 shows the schematic diagram of dispersion of cement particles with the addition of SNF and PCE superplasticizers.

There are several studies done based on the comparison between SNF where molecules are adsorbed on the cement grains that leads to electrostatic repulsion and PCE, where the adsorption leads to both electrostatic repulsion and steric hindrance (Zhang et al. 2015, Ramachandran 1998).

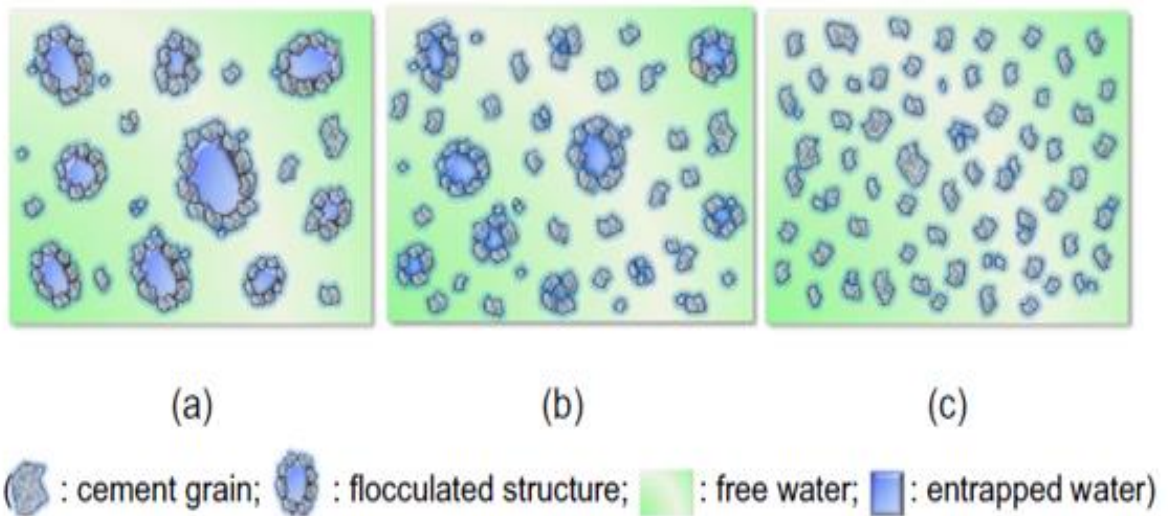

Figure 2.5 Schematic diagram showing the effect of superplasticizer on (a) fresh cement paste without admixture (b) fresh cement paste with SNF (c) fresh cement paste with PCE (Zhang et al., 2015)

Zhang et al. (2015) showed that SNF follows a Langmuir monolayer adsorption isotherm whereas, PCE exhibits multilayer adsorption. The fluidity and retardation of SNF are proportional to the surface coverage on cement grains. At low dosages, the adsorption increases linearly and reaches a plateau indicating the saturation level (Figure 2.6).

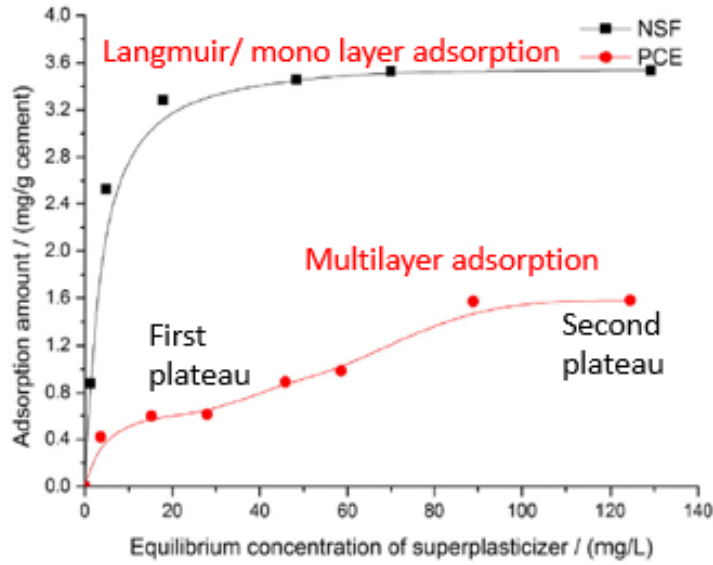

Figure 2.6 Adsorption isotherm of PCE and SNF admixtures (Zhang et al., 2015)

PCE molecules form negatively charged ions in an alkaline aqueous medium (Zingg et al. 2008). Hence, the first layer of adsorption of PCE occurs because of its adsorption on positively charged surfaces of AFt and C₃A phases due to electrostatic forces. Also, it is understood that the COO⁻ ions form a strong complex with Ca²⁺ ions present in the pore solution (Pourchet et al. 2007). As a result, a second layer of adsorption also occurs with Ca²⁺ ions forming a bridge between the two layers of adsorbed COO⁻ ions. This double layer adsorption of COO⁻ ions on the surface of cement grains is schematically shown in Figure 2.7.

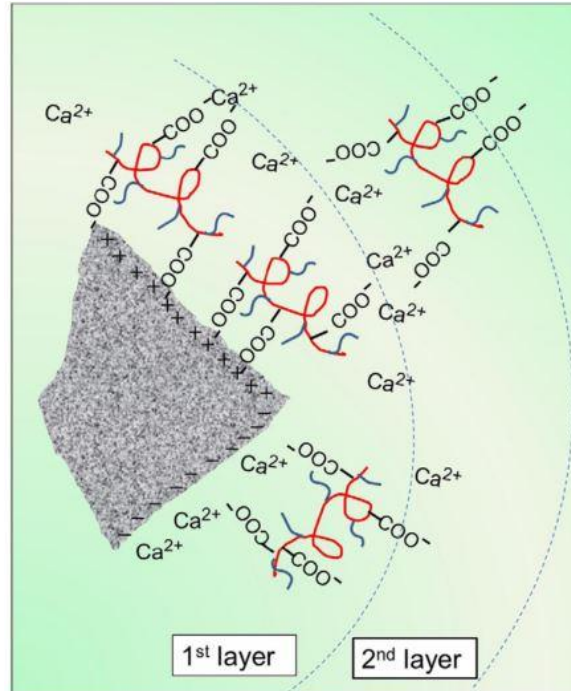

Figure 2.7 Schematic diagram of the two layer adsorption of PCE molecules on cement grain (Zhang et al. 2015).

2.3 Factors affecting cement and superplasticizer compatibility

The major requirements for high performance concrete in the fresh state such as maximum possible reduction in water-to-cement ratio, greater workability, reduction in yield stress and viscosity, depend on the cement and admixture compatibility. Superplasticizers are added to improve the rheological properties and also influence the hydration kinetics and setting time of the cement systems. However, beyond a critical dosage of superplasticizer, there can be sedimentation of cement particles and aggregate due to very low yield stress (Flatt and Houst 2001). It has to be noted that same superplasticizer does not produce the same fluidity with different types of cement and different superplasticizers cannot produce same fluidity with the same cement (Ramachandran 1984). The wrong combinations can cause low fluidity, rapid/delayed setting, segregation etc. which can be collectively called as incompatibility (Aitcin 1994). The cement-admixture compatibility depends on both

cement and admixture properties. The factors related to admixtures are their dosage, time of addition, molecular weight and their chemical structure (Yamada et al. 2000, Uchikawa et al. 1995, Maeder 2003, Yoshioka 1997, Kirby 2004). These are explained in Sections 2.2.1 and 2.2.2. The factors that are related to cements which affect compatibility are their fineness (Chandra and Bjo 2002), chemical and mineralogical composition, free lime content (Plank 2006, Zingg et al. 2009, Alonso et al. 2007), amount and type of calcium sulphate and alkali sulphates (Yamada et al. 2001, Magarotto 2003). The addition of mineral admixtures also affects the cement-admixture compatibility. The following sections describes the some of the major factors related to cement that affects the cement-superplasticizer compatibility.

2.3.1 Effect of C₃A/SO₃ ratio

The influence of C₃A is an important factor that affects the cement admixture compatibility. The superplasticizer adsorption mainly depends on the amount of C₃A and soluble alkali sulphates in the cement. The admixtures that adsorb on both aluminates phases and silicate phases give better fluidity. Compared to silicate phases, aluminate phases have a higher affinity for superplasticizer because of their high positive zeta potential value than silicate phases (Flatt and Houst 2001, Yoshioka et al. 2002)

For PCE admixtures, in the absence of soluble sulphates, the adsorption is greater by cubic-C₃A. The adsorption depends on the carboxylic/ester (C/E) ratio i.e. higher the C/E ratio higher will be the adsorption. In the presence of sulphates, the competition between admixture and sulfates for the adsorption on C₃A sites depends on the C/E ratio and the

amount of sulfates present in the solution for PCE admixtures. The delay in hydration will be higher if the carboxylic/ester ratio is higher (Alonso and Puertas 2015).

Studies done by Alonso et al. 2015, showed that due to the competition between sulfonate groups in SNF and sulfates in the medium, SNF adsorbs more effectively on to cubic-C₃A than PCE admixtures. The affinity for sulphates over admixtures is greater in orthorhombic-C₃A than cubic-C₃A. The impact of admixture over sulphates is very low in orthorhombic-C₃A compared to cubic-C₃A. There is an impact on the hydration reactions also due to the interaction between admixture and C₃A sites. For SNF admixtures, due to the greater adsorption and more effective competition with surface ions, the delay in hydration is longer than PCE admixtures (Alonso and Puertas, 2015).

2.3.2 Effect of fineness of cement

High early strength development is one of the major reasons for widely using high performance concrete (HPC) in practical applications. This is achieved by the higher fineness of cement. The effect of fineness of cement on the rheological properties is not well understood. When the cement is incompatible with the superplasticizer the effect of fineness is more prominent. The increment in Blaine's fineness affects the yield stress of the cement pastes greater than the viscosity of the paste. For SNF admixtures, the amount adsorbed will be increased because of the increased number of fine particles during the grinding process. Generally, for SNF admixtures, as the hydration progresses, the molecules adsorbed on the solid surface are ineffective due to the formation of new hydration products. So, when the fineness of cement is higher, the excessive early adsorption leaves little free SNF molecules for replacing the SNF consumed in the

hydration product (Aydin et al. 2009). The increase in fineness increases the rate of reactions also. The hydration process influences the fluidity loss of the paste. If there is an acceleration in the hydration process, it results in flow loss. Similarly, retardation in the hydration process reduces the flow loss (Chandra and Bjo 2002).

2.3.3 Incompatibility issues

The major incompatibility issues that arise due to the use of admixtures are variations in flowability, uncontrolled setting, anomalous rheological behaviour and so on (Alonso et al. 2013). The interaction problems between cement and superplasticizer can be classified into two groups such as (1) issues related to the adsorption of admixture on the cement grain (2) issues due to the effect of admixture on the hydration of cement particles. The incomplete understanding of the microstructure, hydration and rheological behaviour is mainly due to the huge variations in formulations of commercially available admixtures (Aydin et al. 2009; Hanehara and Yamada 1999).

2.3.4 Effect of superplasticizer on fresh and hardened properties of concrete

The fluidizing effect of admixtures was reported to be greater in mortars made with blended than with ordinary cement (Sahmaran 2006). The addition of superplasticizers has a significant influence on the cement hydration kinetics. The dissolution of ions from the surface of cement grains is hindered by the adsorbed superplasticizer layers. The growth kinetics and morphology are also changed because of the dispersion of cement grains by superplasticizers (Mollah et al. 2000). The setting time of cement paste will be delayed if the concentration of the carboxylic and sulfonic groups remaining in the solution is higher (Yamada et al. 2000). The dispersing capability of PCE is greater than that of SNF. At least twice the dosages of SNF are required for that of PCE to achieve similar rheological

properties (Zhang et al. 2001). This is because of the superior dispersion of PCE brought about by steric repulsion. Considering the hardened properties, the retarding action of PCE admixtures does not adversely affect the early strength and improves the final strength at w/c ratios ranging from 0.4 - 0.5. However, if the dosage of the admixture is increased substantially, there will be the formation of clusters of entangled polymers and cement particles, thereby reducing early strength and little increment in the final strength (Anagnostopoulos et al. 2014).

2.4 INTERACTION OF CHEMICAL AND MINERAL ADMIXTURES

Cost-effectiveness and improvement in the properties of concrete makes the partial replacements of cement with mineral admixtures a common practice. Cost-effectiveness is achieved by less energy requirement in the process of manufacturing due to the re-use of industrial by-products such as fly ash, granulated blast furnace slag etc. It also makes the cement eco-efficient by lowering the greenhouse gas emissions and energy consumption (Rosković and Bjegović 2005). The rheological characteristics of blended cements depends on the specific surface, surface charge and reactivity characteristics of the mineral admixtures used (Burgos-Montes et al. 2012). The fluidity can be improved by the addition of superplasticizers. The mineral admixtures have an effect on the interaction between cement and superplasticizer. The reduction in water-to-cement ratio with increase in workability, decrease in yield stress and plastic viscosity with superplasticizers are all dependent on the compatibility between superplasticizer and the cement used as discussed in the previous sections. Therefore, it is necessary to study the compatibility of mineral additions with superplasticizers.

2.4.1 Interaction of fly ash blends and superplasticizer

The use of fly ash in concrete improves the workability, strength and durability properties (Feldman et al. 1990, Papadakis 1999, Li and Wu 2005, Yilmaz and Olgun 2008). There is a progressive reduction in water content when the replacement of cement by fly ash is increased. This is possible because of the spherical shape of fly ash. If the fineness of fly ash used is greater than cement, then the water demand will be higher because of increase in surface area. Therefore, the particle size, shape, quality and the extent to which fly ash can be replaced affects the workability of concrete (Joshi and Nagaraj 1991, Felekoglu et al. 2009). The workability can be improved with the addition of superplasticizers. Kondraivendhan and Bhattacharjee (2015) studied the flow behaviour and strength for fly ash blended cement pastes and mortars. In most of the studies, the saturation dosages of superplasticizers for the cement are determined using tests methods such as Marsh cone, mini-slump and flow table tests for cement pastes and mortars. The same test methods were used in this study also to understand the flow characteristics of blended pastes with superplasticizers. The results showed that for fly ash blended cement pastes, if the fineness of fly ash is more than cement, the dosage of superplasticizer increases with increase in the fly ash content. Termkhajornkit and Nawa (2004) showed that the zeta potential of fly ash particles was different from that of OPC grains, in both sign and magnitude. Thus, with increasing fly ash addition, the potential barrier between particles became smaller or showed negative values (flocculating systems). For cement-fly ash system containing SNF superplasticizer, the zeta potential of cement grains and fly ash particles had the same sign and hence, the mixture dispersed well due to electrostatic repulsion. The adsorption of PCE on fly ash-blended cement pastes (with 20% of fly ash) was less intense than in non-

blended cement pastes (Li et al. 2005). The amount of PCE admixture adsorbed by fly ash blend is lower than that of non-blended cement. The admixture gets not only adsorbed by cement grains but also by fly ash particles. If the total admixture consumption is taken into account, the consumption does not vary much from non-blended cement because of low amount of fly ash. The rheological behaviour is also similar (Alonso et al. 2013; Kondraivendhan and Bhattacharjee 2015). Fly ash has a greater affinity for SMF than limestone and silica fume blends and shows similar trends in flow properties with SMF and SNF (Burgos-Montes et al. 2012). The rheological studies showed that yield stress and plastic viscosity are reduced in binary blends containing fly ash (Vance et al. 2013a). However, the yield stress is slightly increased when the fly ash replacement level is increased (Park et al. 2005).

2.4.2 Interaction of limestone blends and superplasticizer

Limestone is basically used as inert filler in cementitious systems. However, limestone can also react with alumina to form monocarboaluminate, which leads to a densification of the microstructure. The filler effect of limestone causes acceleration of hydration reactions, improves particle packing and provides new nucleation sites for CSH. The hydration product monocarboaluminate is formed at early stages during hydration and the transformation of ettringite to monosulphate is also delayed (Bonavetti 2001). Depending on the amount and fineness of limestone, C_3S hydration is also accelerated by the presence of $CaCO_3$. The C-S-H gel formed has a significant amount of $CaCO_3$ incorporated into its structure (Ramachandran et al., 1998). Limestone blended cement exhibits similar performance in strength and durability compared to other non-blended cements (Tsilivilis et al. 1999, Ramezani-pour et al. 2009).

Considering the interaction of limestone with superplasticizers, limestone blended cement has greater affinity for polymer molecules. Cement replaced by limestone filler powder showed a slight increase in yield stress and a decrease in plastic viscosity which indicated better stability and fluidity of the cement paste (Nehdi et al. 1996). Most of the studies have focused on the interaction between limestone-blended pastes and PCE based admixture. Compared to other superplasticizers such as SNF and SMF, PCE admixtures adsorb more intensely on limestone blended cement (Burgos-Montes et al. 2012). Mikanovic and Jolicoeur (2008) studied the action of superplasticizer on limestone-blended cement pastes. The results showed that the interaction of superplasticizer with limestone-blended cement pastes varied depending on the type of admixture used i.e. PCE or SNF. The reason is that even though the dispersion effect of water-limestone pastes is similar for PCE and SNF, Ca(OH)_2 improved the effectiveness of PCE. Hallal et al. (2012) compared the effect of limestone powder and natural pozzolan on the fluidity of cement paste containing SNF superplasticizer and melamine-based superplasticizer. For both types of superplasticizers, it was found that the pastes with limestone powder showed better fluidity and relatively lower loss of workability after one hour.

Vance et al. (2015) studied the rheological behaviour of limestone-blended systems. The rheological properties were explained based on Bingham model. The results showed that when coarser limestone powder ($15\mu\text{m}$) is used as replacement for OPC, the yield stress and plastic viscosity is reduced. This is described by the reduction in packing density and specific surface area and increase in spacing between the particles. When fine limestone powder ($0.7\mu\text{m}$ and $3\mu\text{m}$) is used as replacement, the yield stress and plastic viscosity are increased. Santos et al. (2017) showed that limestone filler (up to 5 %) does not modify the

plastic viscosity or yield stress of the paste with PCE admixture. Also, limestone-blended cement pastes cannot control segregation when a high amount of superplasticizers is added.

2.4.3 Interaction of calcined clay and superplasticizer

Kaolin is the most extensively used mineral for industrial applications such as in paper industry, for the production of cement, ceramics, porcelain, bricks etc. (Burst 1991, Murray 1991, Prasad et al. 1991, Cravero et al. 1997, Murray 2000). The kaolin mineral consists of alternate layers of alumina octahedral sheets and silica tetrahedral sheets. The composition includes 46.54% SiO₂, 39.5% Al₂O₃ and 13.96% H₂O (Murray 2000). Upon heating, the Si-O network in metakaolin remains largely intact whereas, Al-O network is reorganized (Grim 1968). Metakaolin contains 50-55% SiO₂, 40-45% Al₂O₃ with small amounts of Fe₂O₃, TiO₂, CaO and MgO (Poon et al. 2001). Metakaolin (MK) is a metastable highly reactive clay produced by heating kaolin over a temperature of 650-700 °C. (Newman 1987, Yip and Deventer 2003). MK is considered as an effective natural pozzolan because of its positive contribution to the improvement in strength, durability and environmental requirements (Cassagnabère et al. 2013). The strength is improved because of its filler effect and accelerated cement hydration. Fernandez et al. (2011) studied the pozzolanic activity of kaolinite, Illite, and montmorillonite calcined between 600 and 800 °C. Because of the higher amount and location of OH group, there was a higher loss of crystallinity in the kaolinite systems. This resulted in a higher pozzolanic activity in systems with kaolinite as compared to the other clays.

The clay rich in kaolin (90%) undergoes thermal activation in the air at 740-840 °C. The breakdown of crystal lattice structure occurs due to dehydroxylation of clay minerals forming a transition phase with high reactivity. This metakaolin reacts with CH to form additional cementitious alumina-containing C-S-H gel. The factors affecting the hydration products and pozzolanic activity are (1) composition of the Portland cement, (2) purity of kaolinite clay used, (3) temperature during calcination and (4) water-to-binder ratio. The compressive strength will be higher if the C-S-H content in the system is higher after hardening (Murat 1983). The three major factors contributing to the strength are (1) filler effect (2) acceleration of cement hydration within first 24 hours and (3) pozzolanic reaction which has the maximum effect within 7-14 days (Sabir et al. 2001).

Even though metakaolin shows significant improvements in strength and durability, the workability is reported to be adversely affected by its use. The studies related to workability of metakaolin showed that the standard workability tests such as slump, compaction factor and Ve-Be test are not good enough to understand the influence of metakaolin on the flow properties especially at low water-to-binder ratios (0.35) (Nehdi 2014). Compared to limestone, metakaolin acts as a modifier of the viscosity of cement pastes. Metakaolin replacement up to 5-8 % improves paste workability. For replacement level of 10 % and above, the workability is greatly reduced and a superplasticizer is needed to improve the workability (Santos et al. 2017). The requirement of superplasticizer is high even to attain a slump of medium workability (Sabir et al. 2001). The yield stress and plastic viscosity is higher in binary blends containing metakaolin. This is due to the higher surface area and agglomeration potential of metakaolin (Vance et al. 2013).

Clays have the ability to readily exchange cations in order to balance the inherent electrical charges on the surface. When chemical admixtures are added, the cations in the clay are readily exchanged with the organic materials present in the admixture. This causes less dispersion and adsorption of chemical admixtures on the surface of the clay. Therefore, most part of the admixture added will be consumed by the clay particles and higher dosages are required to attain the required workability. The high admixture dosage increases the cost and also causes long setting time, delay in strength gain and removal of formwork (Nehdi 2014).

Comparing poly-condensates and polycarboxylic ether based superplasticizers in the dispersing ability, it was observed that polycarboxylic ethers (PCEs) are more sensitive to clays (Nehdi 2014). The dispersing ability is impeded because of the incorporation of PCEs into the layered structure of clay through their side chains. It was observed that different types of PCEs showed noticeable sensitivity to clay and the dispersing force decreased significantly in its presence (Sakai et al. 2006, Lei and Plank 2012). Liu et al. (2004) investigated the reduction in swelling potential of montmorillonite by using KCl in the presence of PEG (Polyethylene glycol) and PAG (copolymers of ethylene oxide and propylene oxide). PAG forms a complex structure with K^+ ions which considerably reduces the swelling potential of the clay. Therefore, copolymer PAG are more commonly used on the side chain for PCE based superplasticizer to be used in cementitious systems containing calcined clay. The decrease in dispersion also depends on the type of clay. Montmorillonite clays have expanding lattices which allow the intercalation, swelling and exchange of cations (Manning, 2007). This is the main reason why kaolinite clays are preferred to Montmorillonite, due to their less harmful effect on concrete fluidity (Jeknavorian et al.

2003). Ng and Plank (2012) found that PCEs undergo physisorption and chemisorption onto clays by 100 times than that on cement. Chemisorption takes place when polyethylene oxide side chains intercalate into the interlayer region of aluminosilicate layers and physisorption occurs on the positively charged clay surfaces by the adsorption of Ca^{2+} ions. Both physisorption and chemisorption are dependent on the dosage. At higher dosages, the side chain intercalation dominates and at lower dosages, electrostatic attraction through the anionic backbone of clay surfaces prevails.

Lei and Plank (2012) developed a new type of PCE to lessen the clay effects and for robustness. The new PCE is modified from methacrylic acid and hydroxyl-alkyl methacrylate esters. The adsorption of PCE was limited only to the clay surfaces and not into the layered structure of clay. The research showed that the modified new PCE was less affected by clay and was able to disperse cement more effectively. Ng and Plank (2012) found that PCEs with high grafting density are more susceptible to influence of clay on their dispersion abilities. They found that poly-glycols can be used as sacrificial agents when PCEs with high grafting chains at high dosages are used in clays. However, it was also suggested that more understanding and experience has to be gained to establish this in practice.

2.4.4 Interaction of limestone-metakaolin blends

The combination of two mineral admixtures, i.e. a ternary blended system, often gives a better performance in workability, strength and durability compared to a binary blended system. The cement – fly ash – GGBS ternary system has practical difficulties because of the slow reactivity of fly ash and workability issues using GGBS. Metakaolin has greater reactivity but workability issues arise due to higher fineness. In the case of limestone due

to its filler effect, the rheological properties as well as strength can be improved. The aluminosilicate SCMs blended with limestone/portland blended system have shown to be superior to other SCMs. This is because of the higher specific surface area of the blend, which ensures faster hydration reactions and also the participation of carbonates from the dissolution of limestone to form the space filling monocarboaluminate (Mehdipour et al. 2017). Therefore, the limestone-metakaolin ternary blended system derives such benefits from the combination. The replacement of clinker by 30% metakaolin and 15% limestone out of this total 45% replacement showed better mechanical properties at 7 days and 28 days than ordinary portland cement (Antoni et al. 2012). Also, the metakaolin reacts faster with limestone than in metakaolin/portland binary cement blend. Similarly, limestone reacts faster with metakaolin system than limestone/portland binary cement blend. The effect of gypsum is another important criterion to be considered in this system. The early age strength is affected by controlling the reactivity of aluminates if the gypsum level is high. Also, the lack of sulphates can cause flash setting issues (Antoni et al. 2012; Krishnan et al., 2015). Along with the improvement of mechanical properties, there is also a large reduction in the energy consumption and CO₂ emission while using limestone-metakaolin blends (Tironi et al. 2017).

The reaction is such that one mole of calcium carbonate reacts with one mole of metakaolin in the presence of excess calcium ions in aqueous solution to produce one mole of monocarboaluminate phase, as per Equation (2.1) (Antoni et al. 2012). The monocarboaluminate forms supplementary AFm phases and stabilizes the ettringite.

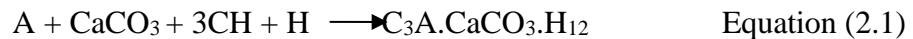

Most of the studies performed on limestone-metakaolin-portland ternary combination are on the performance of limestone calcined clay blends in the hardened state. Only a few papers have focused on the rheological properties of this ternary blended system. Some of these studies are discussed below:

Courard et al. (2011) studied the effects of limestone fillers containing swelling clays on the fresh and hardened properties of self-compacting mortars. The results showed that with the increase in the content of swelling clay, the workability was decreased. There was no major influence on hardened properties and porosity because of the swelling clay content irrespective of its effect on fresh properties. However, this effect can be compensated with adequate dosage of a compatible superplasticizer. Therefore, it is essential to identify the compatible superplasticizer with this type of blend.

Vance et al. (2013) studied the rheology of binders containing portland cement, limestone and metakaolin or fly ash. Combinations of OPC, limestone (10 and 20% replacement with different particle sizes of 0.7, 0.3 and 15 μm) and metakaolin (5 and 10% substitution by mass) with volumetric water-to-solid ratio (w/s) of 0.40 and/or 0.45 were used in the study. The rheological studies of binary blend combination of limestone (5% replacement) and OPC showed that there is no reduction in plastic viscosity but the yield stress was reduced by 20% with respect to the control mix. There was also a reduction in yield stress with the increase in particle size of the limestone powder. Therefore, replacement with limestone particles coarser than OPC decreased the yield stress and plastic viscosity, whereas, particles finer than OPC increased the yield stress and plastic viscosity. For limestone particles coarser than cement, there is a decrease in particle packing and specific surface area. This reduces the ability of the paste to resist shear. This explains the reason for

reduced yield stress. In the case of metakaolin replaced portland cement paste, yield stress and plastic viscosity were significantly increased because of the high surface area and the tendency of particles to agglomerate.

The rheology of the ternary blend combination of limestone and metakaolin is quite complex. The increase in limestone at fixed metakaolin content caused a decrease in yield stress and increase in the plastic viscosity. In this case, coarser limestone particles significantly reduced yield stress, whereas finer particles significantly increased the yield stress. Even though the addition of fine limestone reduces the particle spacing and increases the yield stress, the electrostatic attraction between the negatively charged metakaolin and positively charged limestone particles increases the interparticle spacing and thereby reduces the yield stress. The plastic viscosity increases with increase in metakaolin content and is invariant with the limestone content. The influence of superplasticizer into this ternary combination system was not covered in the study.

Zaribaf et al. (2015) studied the compatibility of superplasticizers with limestone-metakaolin blended cementitious systems. ASTM C595 Type IL cement (15% limestone) with 10 and 30% metakaolin substitution by mass was used for the study. The superplasticizers used were commercially available polycarboxylic ether (PCE), sodium lignosulfonate, naphthalene formaldehyde condensates (SNF) and polymelamine formaldehyde (SMF). The pastes were prepared at water-to-binder (w/b) of 0.40. The saturation dosages of superplasticizers were selected from the mini-slump tests for a corresponding spread of 12 cm. Also, flow tests were done at different substitution levels of metakaolin ranging from 10 – 40% metakaolin substitution by mass and compared with control cement paste (no metakaolin) to understand the trend between metakaolin

substitution and superplasticizer dosage requirement. The results showed that out of the four types of superplasticizers, SMF and lignosulphonate required a dosage of superplasticizer greater than the maximum recommended dosage to attain the flow values similar to control pastes. PCE and SNF based superplasticizers were found more compatible with limestone- metakaolin blended cement. The increase in metakaolin substitutions shortened the setting time and decreased the workability. This was compensated by the addition of adequate dosages of compatible superplasticizers. Finally, the mortar specimens prepared with the combination of Type1L cement and 30% metakaolin substitution by mass with PCE based admixture showed an increase in compressive strength compared to control blend (no metakaolin).

Santos et al. (2017) studied the rheology of cement paste with metakaolin and/or limestone filler blended system. The pastes were prepared with different metakaolin and/or limestone filler (maximum replacement level up to 20 %) with constant water/cementitious materials of 0.3 and 0.5 wt.% polycarboxylic ether type superplasticizer. The fresh properties such as slump and spread, Marsh funnel time, yield stress and plastic viscosity, viscoelastic properties and thixotropy were evaluated. The results showed that spread was low and Marsh funnel time was high when the metakaolin content increased to more than 10%. The rheology studies were done using stress controlled oscillatory rheometer. Metakaolin increased the plasticity and thixotropy of cement paste up to 5-8%. However, beyond 10% of metakaolin the workability was adversely affected. It was found that the increase in metakaolin content increased the yield stress and G' (elastic modulus) of the pastes, whereas, limestone filler up to 10% did not change the yield stress compared to the Portland cement pastes. The workability was improved by the addition of PCE based

superplasticizer. The study concluded that the blend with 90% portland cement, 5% metakaolin and 5% limestone filler gives good thixotropy.

2.5 SUMMARY OF LITERATURE AND NEED FOR THE STUDY

The mechanisms, interaction of superplasticizers with cement and factors affecting compatibility were covered in the initial part of the chapter. The subsequent part discussed the advantages of using mineral admixtures in the cementitious systems and the interaction of superplasticizer with the mineral additions used. The flow behaviour of ternary blended limestone-calcined clay-OPC (LC³) relevant for the present study was discussed in detail. From the literature review, it is clear that for the ternary blended combination of OPC, limestone and metakaolin to achieve sufficient workability, the use of superplasticizer is essential. There is limited research on the rheology of limestone-metakaolin-OPC blended cement in combination with superplasticizers. The compatibility of this ternary blended system with different types of superplasticizer at different water-to-binder ratios has not been adequately addressed.

From the literature study, the following research needs are identified:

- The selection of type of admixture is vital for a blended combination. Since LC³ is a ternary blended combination of OPC with limestone and clay, it is necessary to identify the compatible admixture which gives good workability without compromising the strength requirements.

- It is necessary to determine the dosage of commercially available superplasticizers required for achieving a given workability with LC³ cements.
- For using LC³ in long haul applications like ready mix concrete, it is necessary to determine the workability retention time with commercially available superplasticizers.

CHAPTER 3

MATERIALS USED FOR THE STUDY

3.1 INTRODUCTION

This chapter presents the details of the physical and chemical properties of the materials used for the study. The raw materials used for the experiments in this study include ordinary portland cement, fly ash, limestone calcined clay cement (LC³), fine aggregate (river sand), 10 mm and 20 mm NMSA coarse aggregate (crushed granite), water, and two types of superplasticizers – polycarboxylic ether (PCE), sulphonated naphthalene formaldehyde (SNF).

3.2 TYPES OF CEMENT USED

3.2.1 Ordinary portland cement

Ordinary portland cement (OPC) – 53 grade conforming to IS 12269 – 2009 was used for the study. The physical properties and chemical composition of the cement are presented in Table 3.1 and 3.2 respectively.

3.2.2 Fly ash

Class F fly ash conforming to IS 3812 (Part 1):2003 was used as a supplementary cementitious material for partial replacement of cement. The class F fly ash was obtained from North Chennai thermal power station. The physical properties and chemical composition are presented in Tables 3.1 and 3.2, respectively.

3.2.3 Limestone calcined clay cement (LC³)

Limestone calcined clay cement (LC³), a ternary blended system with – with 50% clinker, 30% calcined clay, 15% limestone and 5% gypsum, was used. LC³ was produced in an industry trial by intergrinding the components in a ball mill (Bishnoi et al. 2014). The physical properties and chemical compositions of this cement are given in Table 3.1 and Table 3.2, respectively.

3.3 AGGREGATES

River sand (0-4.75 mm) conforming to Zone II of IS 383 (2016) was used as fine aggregate. Crushed granite coarse aggregates of size range 4.75-10 mm and 10-20 mm were used in 50:50 proportion. The sieve analyses for both fine and coarse aggregate based on IS 2386 (2007) are shown in Figure 3.1 and Figure 3.2. The aggregate properties, determined as per IS2386 (2007), are listed in Table 3.3.

Table 3.1 Physical properties of OPC, fly ash and LC³

Properties	OPC	FA30	LC ³
Specific gravity	3.16	2.77	3.01
Water demand for standard consistency (%)	30	31	33
Initial setting time (min)	124	120	101
Final setting time (min)	245	280	165
Blaine's fineness (m ² /kg)	340	330	520
Soundness (mm)	0.2	0.2	0.1
Mortar compressive strength at 28 days (MPa)	61	46	43.7

Table 3.2 Chemical composition of cement, fly ash and LC³

Chemical composition	Quantity (% by mass)		
	OPC	Fly ash	LC ³
CaO	64.59	1.28	33.92
SiO ₂	19.01	59.32	30.02
Al ₂ O ₃	4.17	29.95	19.46
Fe ₂ O ₃	3.89	4.32	3.59
MgO	0.88	0.61	2.16
(Na ₂ O) _e	0.16	0.16	0.45
LOI	1.40		7.47

Table 3.3 Summary of properties of aggregates

Properties	Sand	Coarse aggregate	
		4.75-10 mm	10-20 mm
Specific gravity	2.58	2.76	2.78
Water absorption (%)	0.80	0.41	0.30
Bulk density (kg/m ³)	1607	1510	1612
Crushing value (%)	-	-	43
Impact value (%)	-	-	25

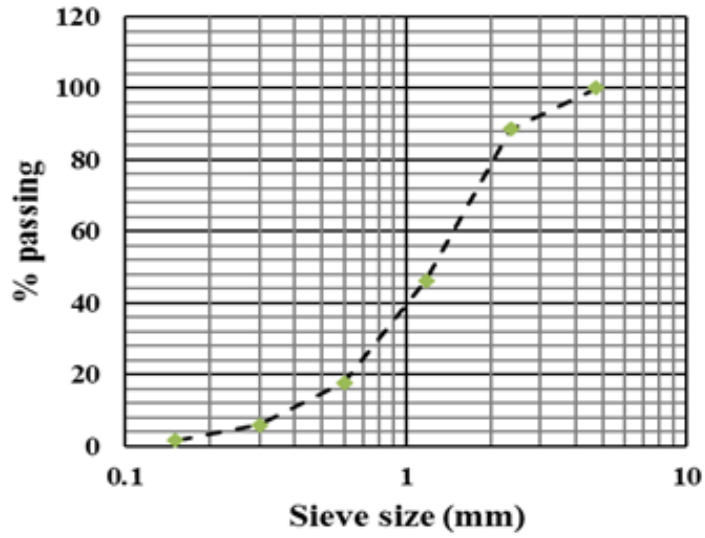

Figure 3.1 Particle size distribution of fine aggregate (0-4.75 mm)

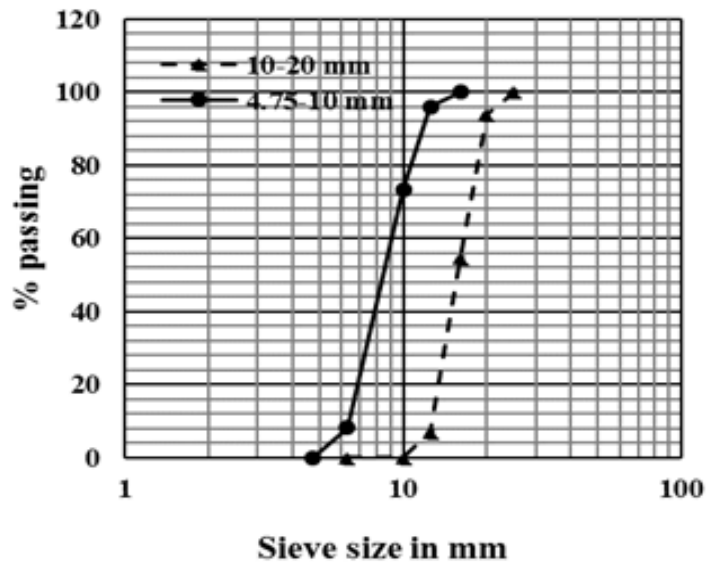

Figure 3.2 Particle size distribution of coarse aggregate (4.75-20 mm)

3.4 WATER

Potable water conforming to IS 456-2005 was used for all the paste and concrete mixes.

3.5 SUPERPLASTICIZER

Commercially available polycarboxylic ether (PCE) and sulphonated naphthalene formaldehyde (SNF) superplasticizers were used for the study. The relevant properties of the superplasticizers as per IS 9103-2004 are given in Table 3.4.

Table 3.4 Properties of superplasticizer

Superplasticizer characteristics	PCE	SNF
Solid content (%)	34.0	44.5
pH	≥ 6	7-8
Density (kg/L)	1.08	1.17

The superplasticizer dosages used in the study are presented in terms of the solid content.

The water content in the superplasticizer has been accounted for in the water content of the mixes.

CHAPTER 4

DETERMINATION OF SATURATION DOSAGE OF SUPERPLASTICIZER

4.1 INTRODUCTION

This chapter presents the determination of saturation dosage of superplasticizer of different types of cement at different water-to-binder ratio. The flowability and cohesion are mainly provided by the paste phase in concrete (Agullo et al. 1999). The results from the paste studies gives an insight of the flowability of concrete. The influence of type of cement, mineral admixture, and type of superplasticizer on fluidity can be analyzed conveniently on pastes rather than concrete. The combination of cement, water, mineral admixture and chemical admixtures should be in the right proportions to meet the desired fresh and hardened properties. However, when blended systems are used, it is important to determine if the chosen chemical admixtures are compatible with the given combination of binder. Superplasticizers that function suitably for portland cement pastes may not be effective for pastes blended with mineral admixtures. In order to evaluate the fluidity of cement pastes, simple and convenient test methods are essential. The Marsh cone and mini-slump tests are simple, reliable, economical and convenient test methods for studying the flowability (de Larrard et al. 1990, Aitcin 1994, Agullo et al. 1999, Roussel and Roy 2005). In this study, the flow time of LC³, FA30 and OPC cements with different dosage of superplasticizers was determined. The minimum superplasticizer dosage which gave the least flow time was then considered as the saturation dosage.

4.2 METHODOLOGY

4.2.1 Cement paste preparation

In the present study, tests were conducted on cement paste with water -to-binder ratios of 0.35, 0.40 and 0.45. The type of cement and superplasticizers used for the study were discussed in Chapter 3. Superplasticizer dosage is expressed in terms of sp/c i.e. ratio of solid content of superplasticizer to cement content by weight. The cement paste was mixed using distilled water. All the test materials were kept in the environmental chamber at a temperature of 25 °C and 65 % relative humidity for 24 hours prior to testing.

The paste was prepared using a 5-litre Hobart-type blender and a B-flat beater with a shaft speed of 139 rpm and planetary speed of 61 rpm. The mixing was performed in the following sequence for all the cases. Initially, cement and 70 % of the water required were mixed together in the mixer for one minute. The superplasticizer and remaining water were then added to the cement paste. The water content in the superplasticizer was deducted from the water added. The paste was mixed for two minutes at the same speed. The mixer was then stopped and sides of the bowl and blades were scraped (15-20 seconds), and then the paste was again mixed for two minutes. For the mixes without superplasticizer, the same procedure was followed except that all the water was added at once. The binary blend combination of OPC with fly ash (FA30) was mixed dry for one minute for homogenization prior to the procedure described earlier. For all the mixes, the total mixing time was five minutes excluding the time taken for dry mixing (Jayasree 2009, Elson 2014).

4.2.2 Marsh cone test

Marsh cone test is a quick and easy method for the optimization of chemical and mineral admixtures (de Larrard 1989, Aitcin 1994, Agullo et al. 1999, Giaccio and Zerbino 2002, Roussel and Roy 2005). The test set up is shown in Figure 4.1. It consists of a metal cone. The cone geometry used is as per the guidelines of European standards EN 445 and French standard P 18-358, which are similar to ASTM C939(1987). The nozzle diameter is usually selected between 8 mm and 12 mm, based on the rheological characteristics of the grout to obtain suitable flow time. For evaluating the fluidifying effect of admixtures in post-tensioning grouts, 12 mm diameter nozzle is used. For the determination of fluidity using chemical and mineral admixtures in cement pastes, 8 mm nozzle is used (Nguyen et al. 2006). In the present study, 8 mm nozzle diameter was used.

The procedure of Marsh cone test was as follows:

- 1000 ml of paste was poured into the Marsh cone by closing the bottom orifice.
- Then, the orifice was opened and the stopwatch was started.
- The time taken for 500 ml of the paste to fill the cylinder kept under the cone was noted.

From the Marsh cone test, the fluidity is represented by a flow curve, as shown in Figure 4.2. The flow curve indicates the flow time of cement-admixture combination with increasing dosages of superplasticizer. The flow time is indirectly related to viscosity of the paste. Higher the flow time, higher is the viscosity. The saturation dosage is obtained from the saturation point of the flow curve. The saturation point is the break point beyond which the fluidity does not significantly increase with further addition of superplasticizer (de Larrard 1989, Aitcin 1994, Agullo et al. 1999). If the superplasticizer is added more

than that of the saturation point, it does not improve the fluidity and results in segregation. The setting time can be delayed due to this segregation effect (Agullo et al. 1999, Jayasree and Gettu 2008, Hallal et al. 2010).

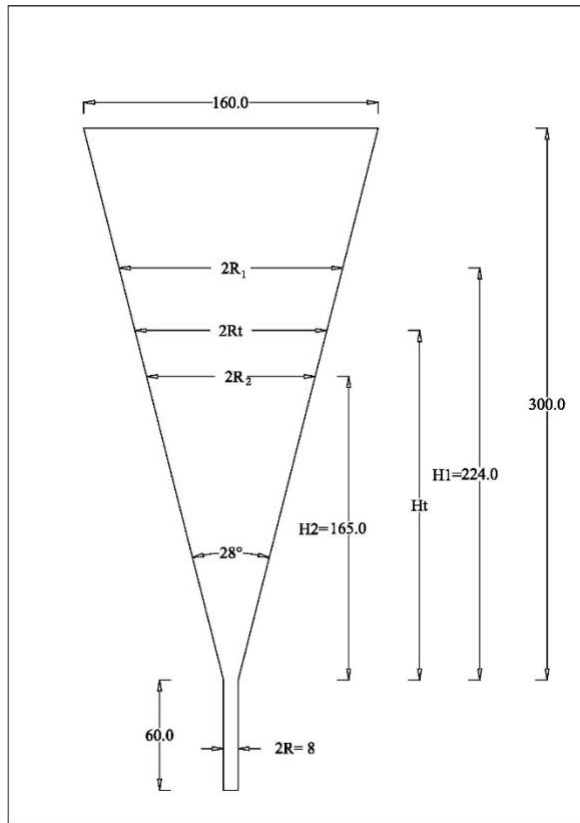

R, H - Radius and length of nozzle

R_1, H_1 - Radius of the free surface and height of fluid in the cone at the initial moment

R_t, H_t - Radius of the free surface and height of fluid in the cone at any time t

R_2, H_2 - Radius of the free surface and height of fluid in the cone at the final moment

ϕ - Angle between the axis and the generator of the cone

Figure 4.1 Marsh cone apparatus (All dimensions are in mm)

Saturation dosage can also be determined from the slope of the curve. Two trials were done for all the combinations of binder and admixture at different w/b ratios. The average value was taken as the saturation dosage. Gomes et al. (2001) proposed a method for the objective determination of the saturation dosage based on the Marsh cone flow time curve of pastes, which is shown in Figure 4.2. In this method, the internal angle (α) corresponding to each data point is calculated and the superplasticizer dosage corresponding to the internal angle

of $140^\circ \pm 10^\circ$ is taken as the saturation dosage. Interpolation is used to determine the dosage when there are no data points corresponding to that range of angles. This criterion was proposed based on about 200 tests on superplasticized cement pastes (Gomes et al. 2002). Although the test method is empirical, Roussel and Roy (2005) developed an analytical model to determine the viscosity of cement paste from the flow time obtained from the Marsh cone test. However, the model was found to be valid only for cement pastes with no yield stress and having flow times higher than 15 seconds.

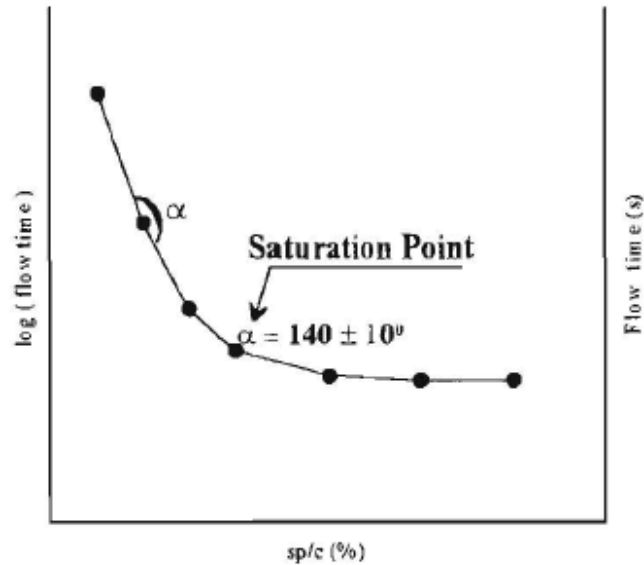

Figure 4.2 Graphical representation to determine the saturation dosage (Gomes et al. 2002)

4.2.3 Mini-slump test

Mini-slump tests represent the estimate of deformability of cement pastes. From literature, the influence of superplasticizer dosage on fluidity can be better understood from mini-slump tests (Svermova et al. 2003, Roussel et al. 2005, Sonebi et al. 2013). Some of the studies have related the value of mini-slump spread with the rheological parameter - yield stress, of the paste. Ferraris et al. (2001) found that a weak correlation exists between mini-

slump and yield stress. The basic principle is that higher the spread value, lower will be the yield stress.

The mini-slump is a mould in the shape of a truncated cone with dimensions proportional to the Abram's cone (Kantro et al., 1980). The dimensions of mini slump cone are given below (Figure 4.3). The mould is placed on a clean glass sheet of suitable dimensions. The mould is then filled with cement paste. After filling, the mould is lifted up vertically and the cement paste is allowed to flow until it stops spreading. After that the diameter of the cement paste is measured in two perpendicular directions. The average value is expressed as the spread of the cement paste. Two trials are done for all the combinations of binder and admixture at different w/b ratios and repeatability was observed. Also, visual examination helps to evaluate the bleeding and segregation of the paste.

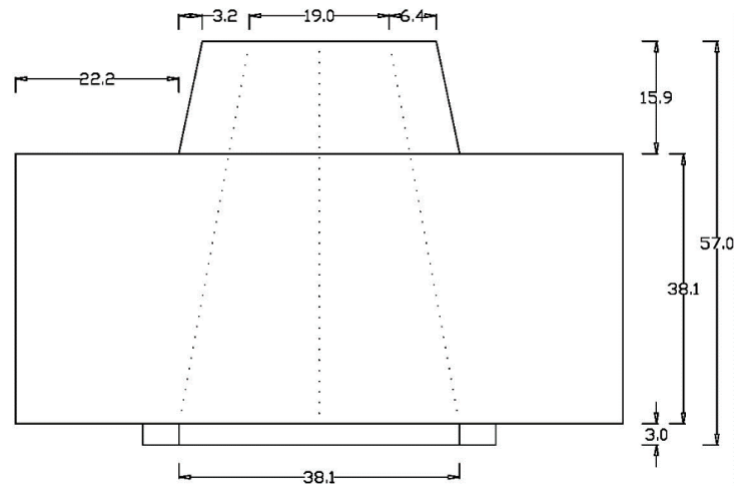

Figure 4.3 Mini-slump test apparatus (All dimensions are in mm)

4.3 RESULTS AND DISCUSSIONS

The saturation dosages identified for the various combinations of cementitious material and admixture at different w/b ratios from Marsh cone tests are shown in Figures 4.4 – 4.9.

From the results, it is seen that beyond the saturation dosage there is no significant change in the flow time and the curves are relatively flat. Fluidity can be considered as a function of two parameters such as (i) water-to-binder ratio (w/b ratio) and (ii) superplasticizer dosage expressed as percentage by weight of cement (sp/c) (Agullo et al. 1999).

The w/b ratio has significant influence on the flow time. The flow time decreases with increase in w/b ratio as expected. At low w/b ratios, there is less amount of water, which decreases the relative fluidity and increases the flow time. Beyond the saturation dosage of superplasticizer, the slope of the curve decreases indicating significant decrease in the viscosity. It can be seen that OPC showed much lower flow times at saturation dosage for all w/b ratios. At w/b ratios of 0.35, 0.40, and 0.45, FA30 and LC³ showed comparable flow times at saturation dosage.

Fluidity increases when the superplasticizer dosage increases. The dispersing ability of the superplasticizer affects the fluidity (Hallal et al. 2010). The saturation dosage with both PCE and SNF for the different blends are summarized in Table 4.1. At w/b ratio 0.45, for OPC the superplasticizer dosage using both PCE and SNF the flow time was very low even without the addition of superplasticizer. Therefore, at 0.45 w/b ratio the flow time was compared between LC³ and FA30. For all w/b ratios, the dosage required to reach saturation was higher for SNF as compared to PCE. For PCE admixtures, the dispersion is caused by both steric and electrostatic repulsion mechanisms whereas, for SNF based admixture dispersion is only due to electrostatic repulsive forces. Due to this reason, higher dosage of SNF is required for better dispersion. Therefore, higher will be the amount adsorbed on the cement particles causing higher fluidity (Collepari 1998, Kim et al. 2000).

It is understood from the graphs that the saturation dosage required for LC³ is greater compared to OPC and FA30 at all w/b ratios. This may be due to the intercalation of superplasticizer molecules between layers of clay (Lei and Plank, 2014). The higher SP requirement may also be due to higher fineness of LC³ as compared to the other blends. This is because specific surface area of the binder is an important parameter that affects the adsorption of superplasticizers. The saturation point increases with the fineness of the cementitious material (Giaccio and Zerbino 2002). The dosage required using SNF is much greater than using PCE based admixture. The type of mineral admixture also affects the flow time. The fluidity can be affected by the combination of cement type, chemical admixture, mineral admixture and w/c ratio. This indicates a requirement of high saturation dosage of the LC³ system and correlates with the present study.

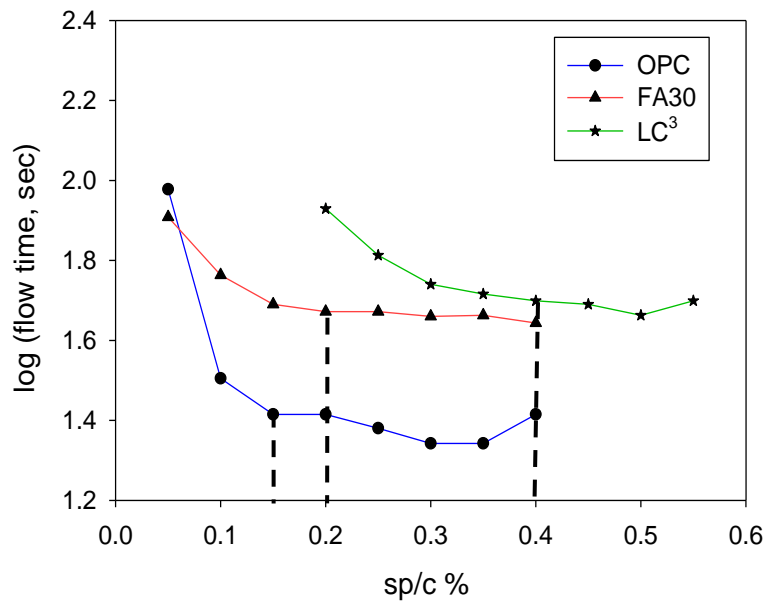

Figure 4.4 Flow curve at w/b ratio 0.35 using PCE admixture

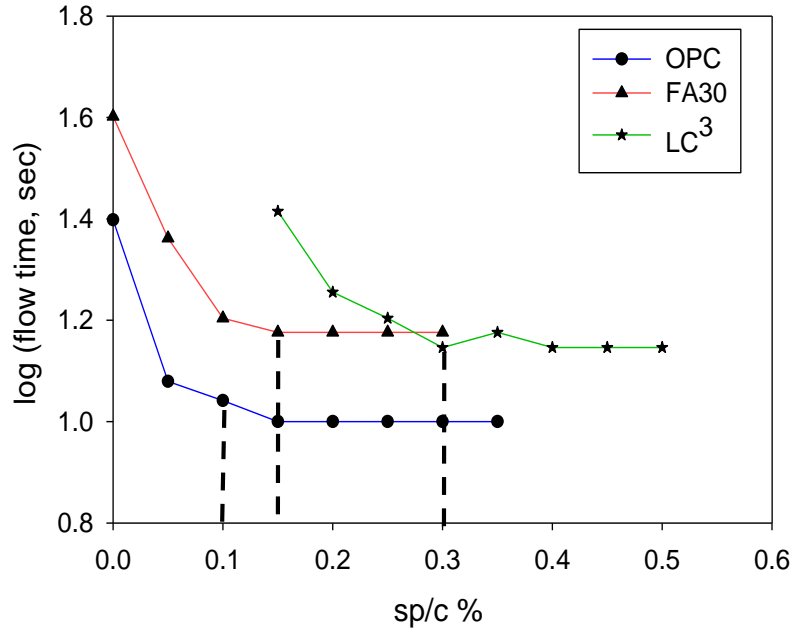

Figure 4.5 Flow curve at w/b ratio 0.40 using PCE admixture

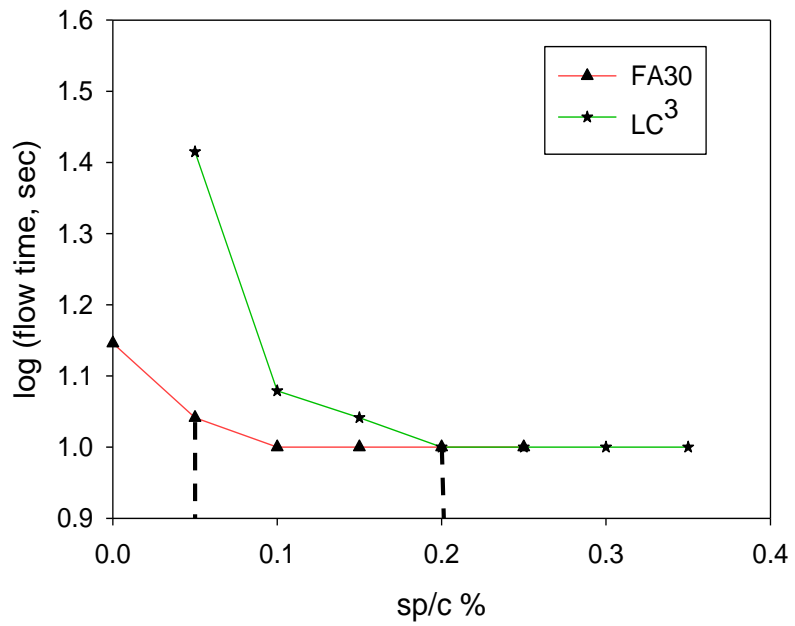

Figure 4.6 Flow curve at w/b ratio 0.45 using PCE admixture

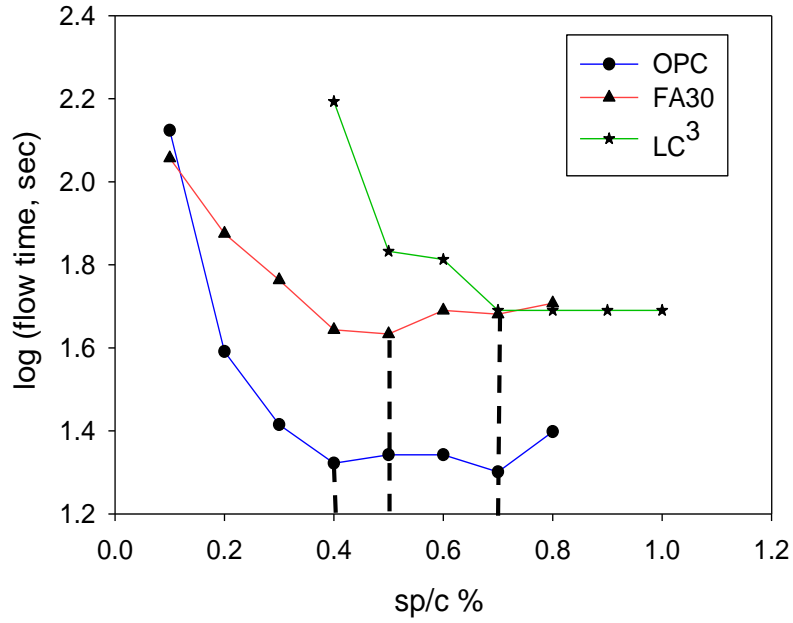

Figure 4.7 Flow curve at w/b ratio 0.35 using SNF admixture

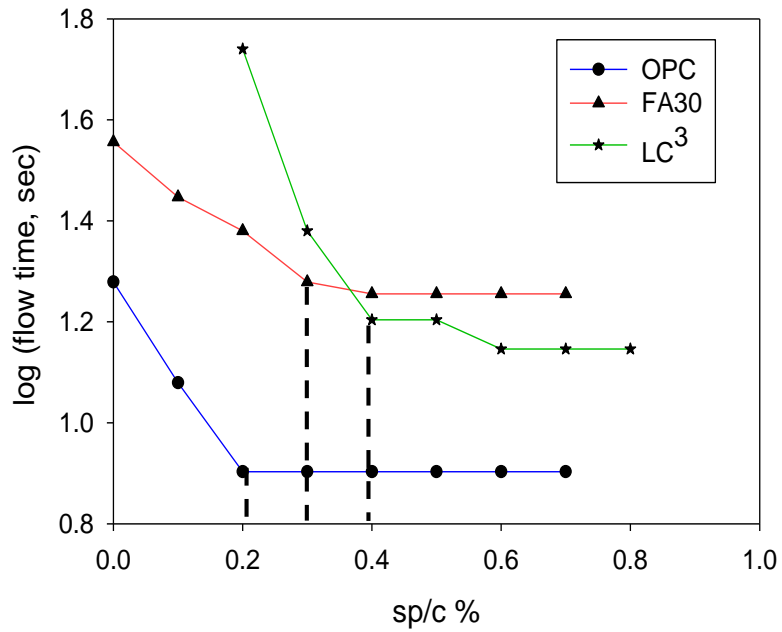

Figure 4.8 Flow curve at w/b ratio 0.40 using SNF admixture

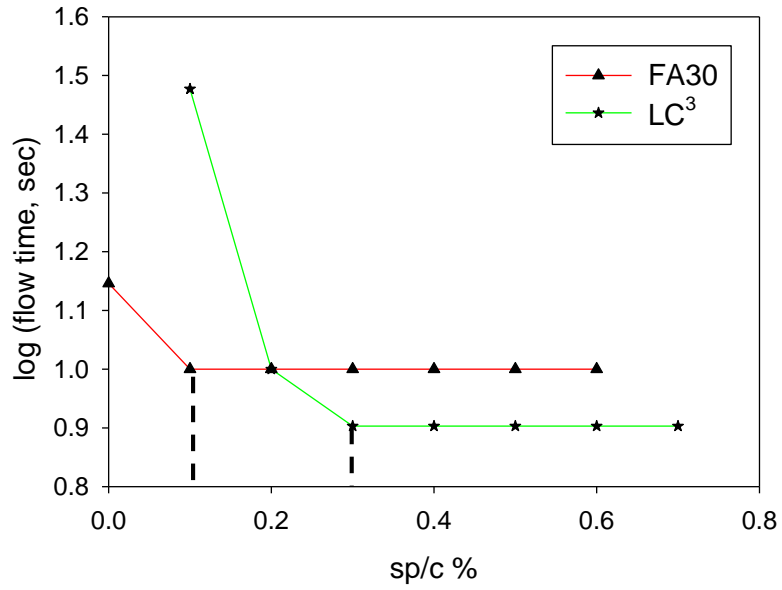

Figure 4.9 Flow curve at w/b ratio 0.45 using SNF admixture

Table 4.1 Summary of saturation dosage determined from Marsh cone tests

Type of Binder	w/b ratio	Saturation dosage of superplasticizer by weight of cement (%)		Flow time corresponding to saturation dosage (s)	
		PCE	SNF	PCE	SNF
OPC	0.35	0.15%	0.40%	26	21
FA30	0.35	0.20%	0.50%	47	43
LC ³	0.35	0.40%	0.70%	50	49
OPC	0.40	0.10%	0.20%	11	8
FA30	0.40	0.15%	0.30%	16	19
LC ³	0.40	0.30%	0.40%	14	16
OPC	0.45	superplasticizer not required	superplasticizer not required	-	-
FA30	0.45	0.05%	0.10%	11	10

LC ³	0.45	0.20%	0.30%	10	8
-----------------	------	-------	-------	----	---

The mini-slump results are influenced by the type of superplasticizer and cement. Figures 4.10 - 4.15 shows the spread curves of LC³, OPC and FA30 using PCE and SNF based admixtures at w/b ratios 0.30, 0.40 and 0.45. From the curves, it is seen that the mini-slump spread value increases up to saturation dosage. Beyond the saturation dosage, there is no significant change in the spread value. Bleeding was observed at very high dosages of superplasticizer, and the data points for those cases have been excluded in the plots.

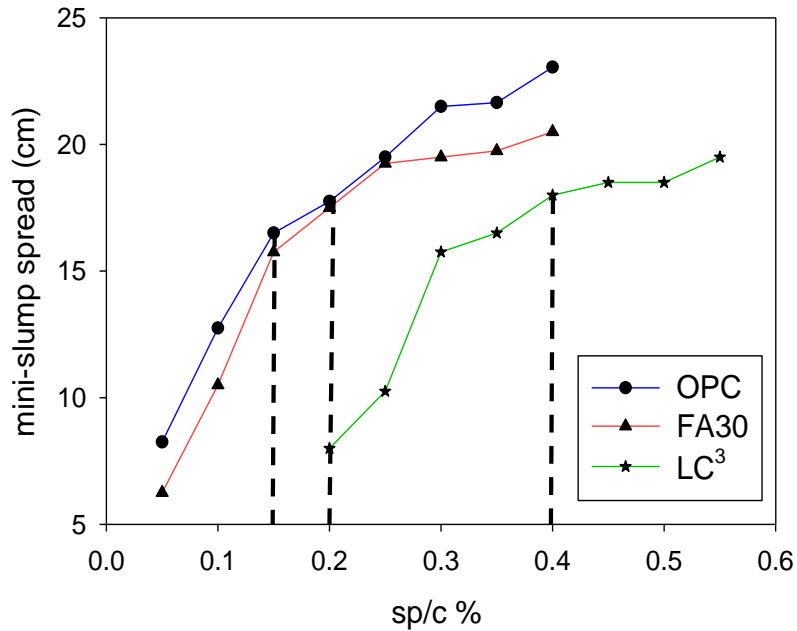

Figure 4.10 Spread curve at w/b ratio 0.35 using PCE admixture

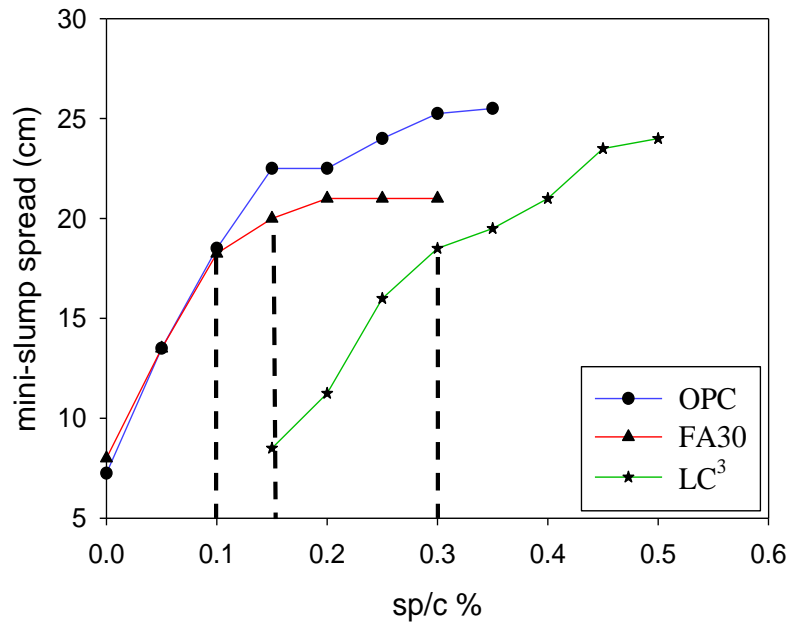

Figure 4.11 Spread curve at w/b ratio 0.40 using PCE admixture

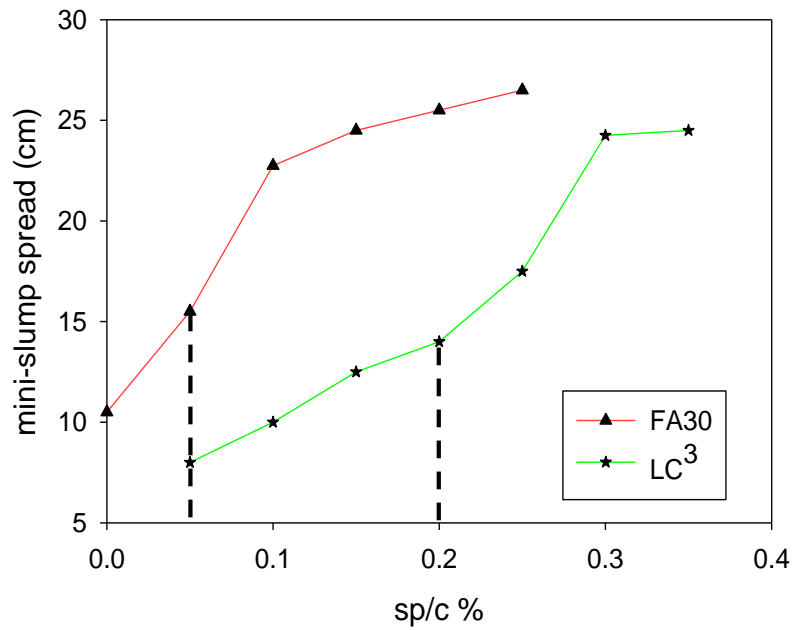

Figure 4.12 Spread curve at w/b ratio 0.45 using PCE admixture

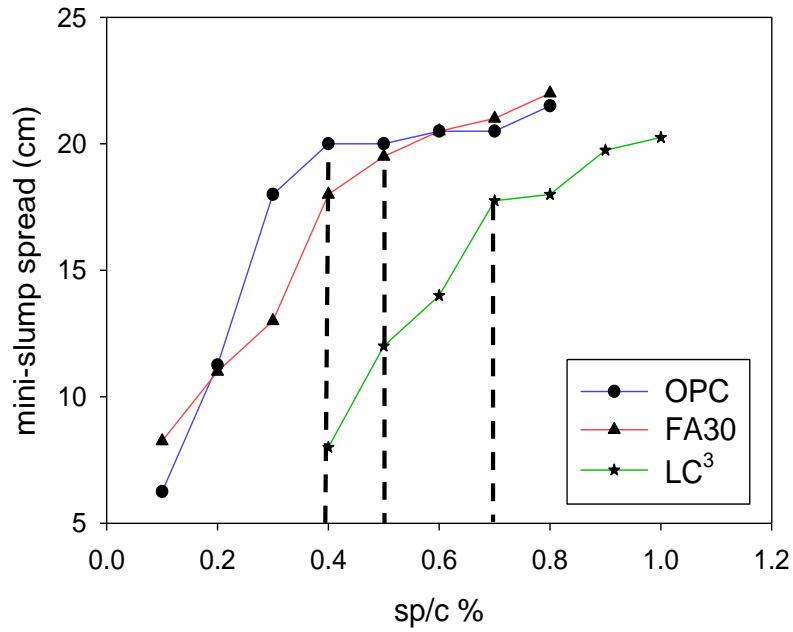

Figure 4.13 Spread curve at w/b ratio 0.35 w/b using SNF admixture

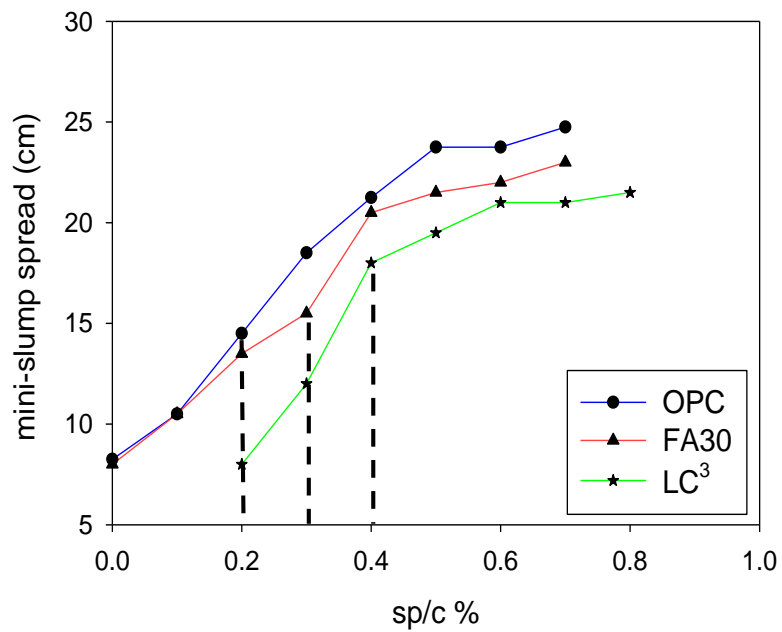

Figure 4.14 Spread curve at w/b ratio 0.40 w/b using SNF admixture

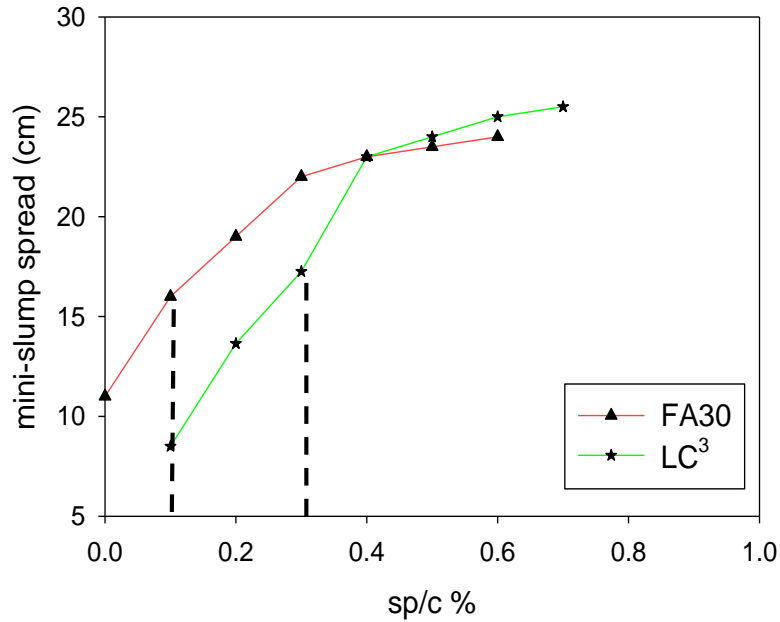

Figure 4.15 Spread curve at w/b ratio 0.45 w/b using SNF admixture

It can be understood from the graphs that LC³ can achieve similar spread as OPC at the saturation dosage at higher water-to-binder ratios. The same trend in Marsh cone is followed in mini-slump test with respect to saturation dosage. LC³ showed greater demand of superplasticizer compared to OPC and FA30. Also, the dosage required to reach saturation level is higher for SNF than PCE based admixture.

4.4 SUMMARY

The variation of flow time according to the type and dosage of superplasticizer is studied at three w/b ratios. The saturation dosage of superplasticizer was determined by the Marsh cone test. It can be concluded that LC³ has greater requirement of superplasticizer to reach saturation dosage compared to OPC and FA30. The higher superplasticizer dosage for LC³ can be due to higher fineness and intercalation of superplasticizer molecules between layers of clay. The saturation dosage of superplasticizer decreases with increase in w/b ratio. For

all w/b ratios, PCE required lower dosage as compared to SNF. Although the flow time obtained from Marsh cone and mini-slump tests gave an assessment of superplasticizer required for each blend, it cannot be easily related to any of the intrinsic fluid parameters like plastic viscosity and yield stress. This necessitates the need for a rheological study, which is presented in the next chapter.

CHAPTER 5

DETERMINATION OF RHEOLOGICAL CHARACTERISTICS

FROM PASTE STUDIES

5.1 INTRODUCTION

The previous chapter discussed about the determination of saturation dosage of superplasticizers for LC³, OPC and FA30 at different water-to-binder ratios. The results obtained from Marsh cone showed that there is a significant change of flow time at the saturation dosage in all the cases. The viscometric studies conducted for pastes with saturation dosage of superplasticizers for different w/b ratios are discussed in this chapter.

5.2 VISCOMETRIC STUDIES

In the case of high performance concrete, the slump tests alone may be inadequate to characterize the rheology of the material. For instance, two concretes having the same slump might show a different behaviour when pumped. Therefore, a more rigorous rheological assessment is necessary to understand the flow behaviour of concrete. The concrete workability can be improved by selecting the type and dosage of admixtures from rheological tests (Ferraris et al. 2001). Due to its simplicity and low cost, the slump test is commonly used in the field than viscometer tests. However, it is difficult to get a correlation between the slump tests and rheological parameters because of the variations in the testing conditions. In this study, rheological studies of cement pastes were performed since the results from the paste rheological studies can give an insight of the flowability of

concrete. Further, admixture compatibility issues especially with LC³ systems can be identified from the paste studies itself.

The various factors influencing the rheological properties can be listed as follows: (a) physical factors such as size and shape of cement grains and w/c ratio, (b) chemical factors, which include cement composition and change in morphology during hydration, (c) mixing conditions, (d) testing conditions, and (e) presence of additives (Papo and Piani 2004). The fluidity and rate of solidification of cement pastes are influenced by the microstructural changes that occur within the cement paste during the hydration process.

One of the commonly used models for representing the flow curve of cement paste is the Bingham model. Bingham model is a two-parameter model characterized by yield stress and plastic viscosity. The yield stress represents the minimum stress required to initiate flow in the material. Below its yield stress, cement paste behaves like an elastic solid. Above its yield stress, the material deforms and flows, becoming plastic. The plastic viscosity is a material constant and is not a function of shear rate. For Bingham materials, the plastic viscosity and yield stress are calculated from a linear fit of the flow curve, with the plastic viscosity being the slope and the yield stress being the intercept (Figure 5.1)

The mathematical interpretation of Bingham model is given in Equation 5.1:

$$\tau = \tau_0 + \mu_p \dot{\gamma}$$

Equation 5.1

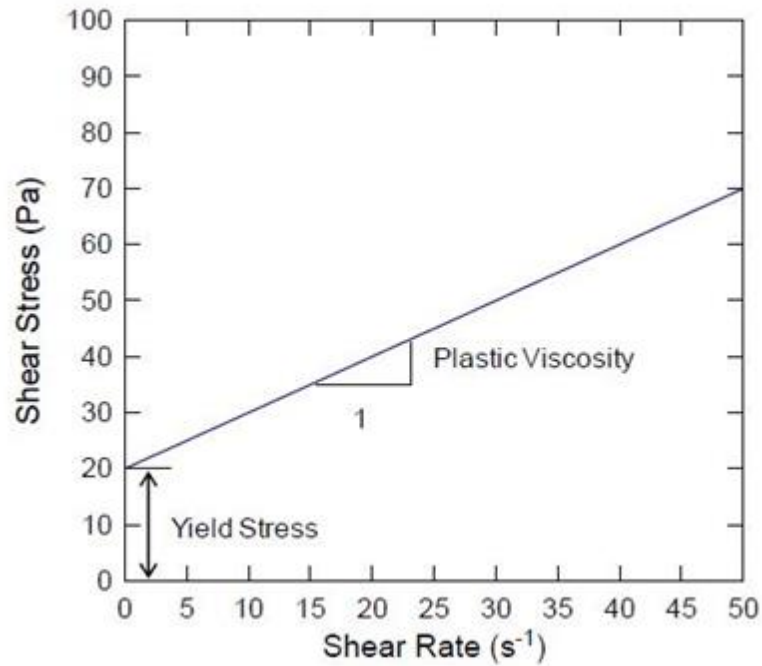

Figure 5.1 Flow curve for a Bingham fluid (Hackley and Ferraris 2001)

Although the Bingham model predicts the flow behaviour of the less viscous cement paste, i.e. with very high w/c ratio, it cannot give an insight into the non-linearity of the flow behaviour. The shear thinning, shear thickening and thixotropic nature of the cement pastes are well predicted by non-linear models such as Herschel Buckley model, Casson model, etc. as shown in Figure 5.2 (Yahia et al. 2001).

Herschel Bulkley (HB) model is a power law model with three parameters in which the viscosity is a function of shear rate (Equation 5.2). The power index represents the non-linearity of the system. So, it can predict the non-linear behavior such as shear thinning and shear thickening.

$$\tau = \tau_0 + k \gamma^n \quad \text{Equation 5.2}$$

where τ_0 is the yield stress, k is the consistency index and n is the power index, which represents the deviation from Newtonian behaviour. If the value of n is less than unity, then it is termed as a shear thinning system and if $n > 1$, it is a shear thickening system. This model reduces to Newtonian equation when $\tau_0 = 0$ and $n = 1$, to the Bingham equation when $n = 1$, and to a power law when $\tau_0 = 0$ (Papo, 1988). The HB model was successfully used for cement paste with different w/c ratios to correlate data obtained by measurements conducted with a cone and plate viscometer (Jones et al. 1977, Atzeni et al. 1985, Yahia et. al. 2001).

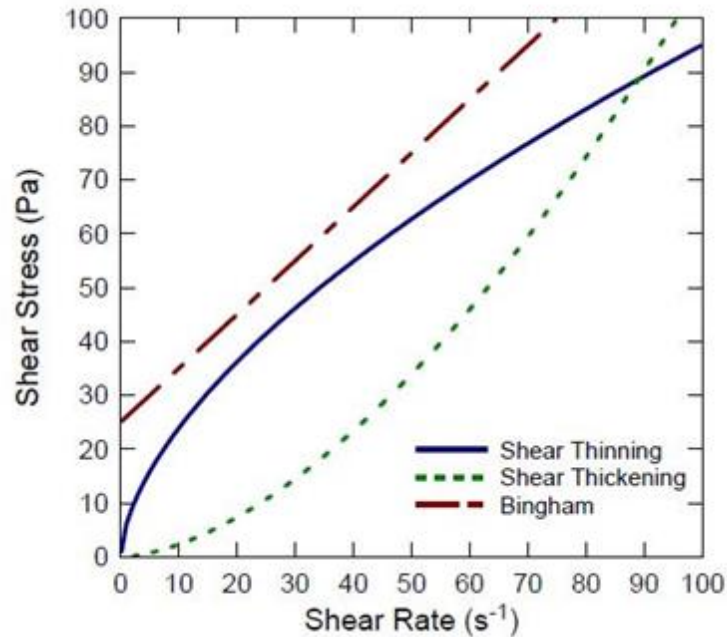

Figure 5.2 Flow curves for non-Newtonian fluid models (Hackley and Ferraris 2001).

The rheological parameters based on Bingham and Herschel-Buckley models are dependent upon the water-to-powder mass ratio, dosage and type of cement replacement materials and the particle size distribution of the solids. Also, the yield stress and plastic

viscosity has direct correlation with the specific surface area and inverse relationship with the water film thickness (Bentz et al. 2012; Vance et al. 2013). Generally, a shear-thinning behaviour is expected from cementitious systems. However, studies have shown that shear thickening behaviour can also happen. Based on the cement grout studies done by Anagnostopoulos et al. (2014), shear thickening behaviour was exhibited by the system at high strain rates irrespective of the type of superplasticizer and w/c ratio. At high shear rates, shear forces can increase the formation of clusters due to Van der Waals' forces of attraction. This creates a barrier against the repulsive forces but it is only temporary. PCE based polymers show this temporary aggregation above a critical deflocculant concentration (Papo and Piani 2004).

5.3 EXPERIMENTAL DETAILS

5.3.1 Materials used

In the present study, tests were conducted on cement paste with water-to-binder ratio 0.35 and 0.40. The type of cement and superplasticizers used are presented in Chapter 3. The cement paste preparation methodology is explained in Section 4.2.1 of Chapter 4. The cement paste was mixed using distilled water. All the test materials were kept in the environmental chamber at a temperature of 25 °C and 65 % relative humidity for 24 hours prior to testing.

5.3.2 Test method using rotational viscometer

In the present study, a Brookfield HA DV II + Pro viscometer was used with a coaxial cylinder setup. The dimensions of the inner cylinder were 16.77 mm radius and 1.14 mm gap width as shown in Figure 5.3. The details of the coaxial test setup are shown in Figure 5.4. The programming of the test was done using Rheocalc software. The basic principle

is to apply a known shear rate to the paste in a viscometer through the rotation of the spindle and measure the corresponding shear stress produced. The protocol developed by Jayasree (2009) was used for the study. The shear rate was increased and later decreased from 23 to 163 s^{-1} in seven steps. Three loading and unloading cycles were done. The shear strain vs time for one cycle is shown in Figure 5.5.



Figure 5.3 Brookfield HA DV II + Pro viscometer (Asphalt Laboratory, IITM)

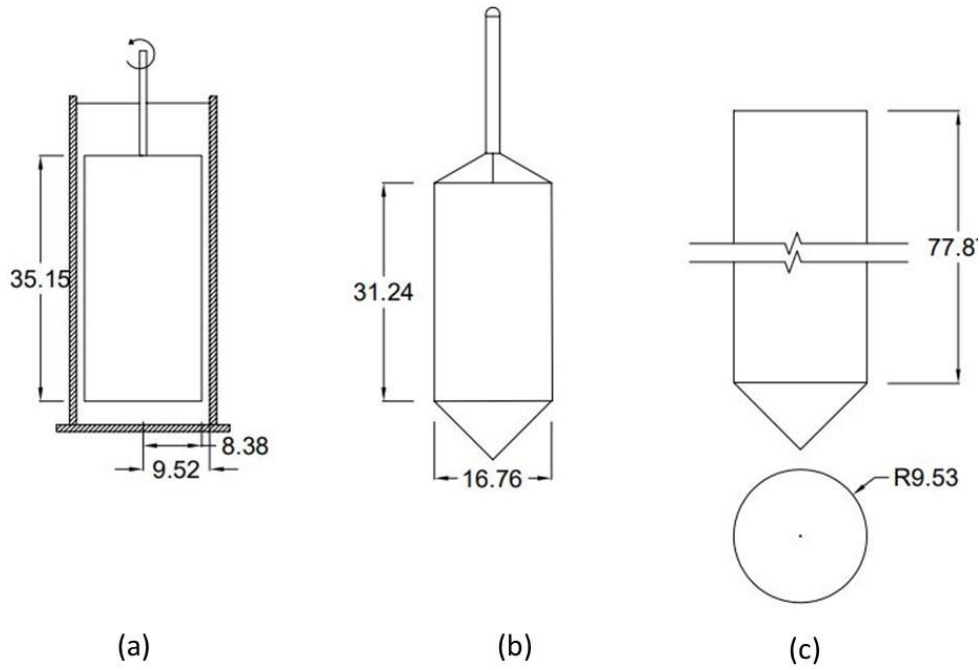

Figure 5.4 Details of coaxial setup (a) co-axial cylinder (b) SC4 21 – spindle (c) HT-2 sample chamber

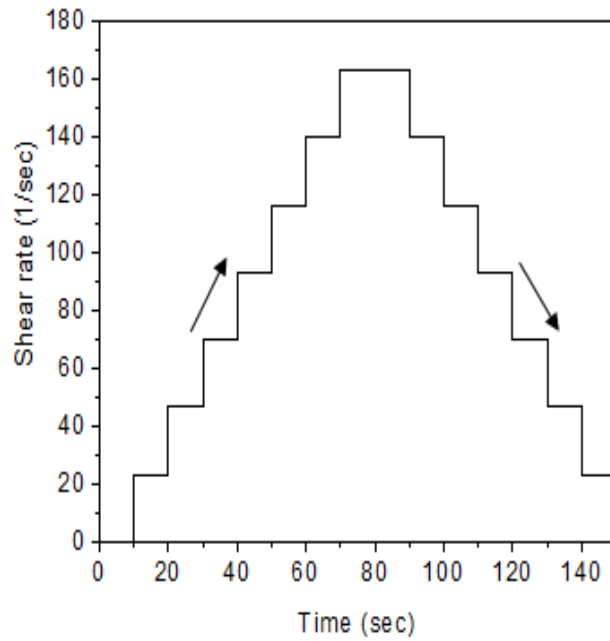

Figure 5.5 Shear strain vs time (Jayasree, 2009)

5.3.3 Issues faced during testing in coaxial cylindrical setup

Jayasree (2009) used the above-mentioned protocol for understanding the rheological characteristics of OPC with w/c ratio 0.30 and different types of superplasticizers. The protocol was developed after multiple trials. The protocol satisfied the instrument torque range capacity of the Brookfield viscometer. The rheological parameters of cement-superplasticizer combination at low, saturation and high dosage of superplasticizer were found by fitting the shear stress-shear rate values with Bingham and Herschel-Bulkley rheological models. However, for the present study, the protocol did not give satisfactory results when the w/b ratio was increased above 0.30. The results were satisfactory when the w/b ratio was 0.30 for OPC-PCE combination. However, for LC³ cement paste, even at saturation dosage of superplasticizer the spindle did not rotate due to the highly cohesive nature of LC³ cement.

When the w/b ratio was increased to 0.40, the torque values were less than the allowable limits as shown in Figure 5.6. The same issue was encountered in several trials. Figure 5.7 shows the graph representing the trials done without superplasticizer for OPC at w/b ratio of 0.35. The torque was within the limits; however, the repeatability was low. Figure 5.8 and Figure 5.9 show the results for the combination of OPC and PCE at low and saturation dosages of superplasticizer at w/b ratio 0.40.

Loop (#)	Step (#)	Point (#)	Viscosity (Pa·s)	Speed (RPM)	Torque (%)	Shear Stress (Pa)	Shear Rate (1/s)	Temp (°C)	Bath (°C)	Time (hh:mm:ss)	Stress (Pa)	Strain (rad)	Density (g/cm ³)
0	1	1	0.06	24.73	1.4	1.3	23	29.8	30.1	00:00:01.1	----	----	----
0	1	2	0.04	24.73	1.1	1.02	23	29.8	30.1	00:00:02.1	----	----	----
0	1	3	0.04	24.73	0.9	0.84	23	29.8	30.1	00:00:03.1	----	----	----
0	1	4	0.09	24.73	2.3	2.14	23	29.8	30.1	00:00:04.1	----	----	----
0	1	5	0.01	24.73	0.2	0.19	23	29.8	30.1	00:00:05.1	----	----	----
0	2	6	0.03	46.24	1.5	1.39	43	29.8	30.1	00:00:06.1	----	----	----
0	2	7	0.02	46.24	1.1	1.02	43	29.8	30.1	00:00:07.1	----	----	----
0	2	8	0.03	46.24	1.3	1.21	43	29.8	30.1	00:00:08.1	----	----	----
0	2	9	0.02	46.24	0.9	0.84	43	29.8	30.1	00:00:09.1	----	----	----
0	2	10	0.02	46.24	0.9	0.84	43	29.8	30.1	00:00:10.1	----	----	----
0	3	11	0.01	67.74	1	0.93	63	29.8	30.1	00:00:11.1	----	----	----
0	3	12	0.02	67.74	1.2	1.12	63	29.8	30.1	00:00:12.1	----	----	----
0	3	13	0.01	67.74	1	0.93	63	29.8	30.1	00:00:13.1	----	----	----
0	3	14	0.01	67.74	0.7	0.65	63	29.8	30.1	00:00:14.1	----	----	----
0	3	15	0.01	67.74	1	0.93	63	29.8	30.1	00:00:15.1	----	----	----
0	4	16	0.01	89.25	0.8	0.74	83	29.8	30.1	00:00:16.1	----	----	----
0	4	17	0.01	89.25	0.7	0.65	83	29.8	30.1	00:00:17.1	----	----	----
0	4	18	0.01	89.25	1.2	1.12	83	29.8	30.1	00:00:18.1	----	----	----
0	4	19	0.02	89.25	1.5	1.39	83	29.8	30.1	00:00:19.1	----	----	----

Figure 5.6 Output data from Rheocalc software for OPC-PCE combination at saturation dosage for w/b ratio 0.40

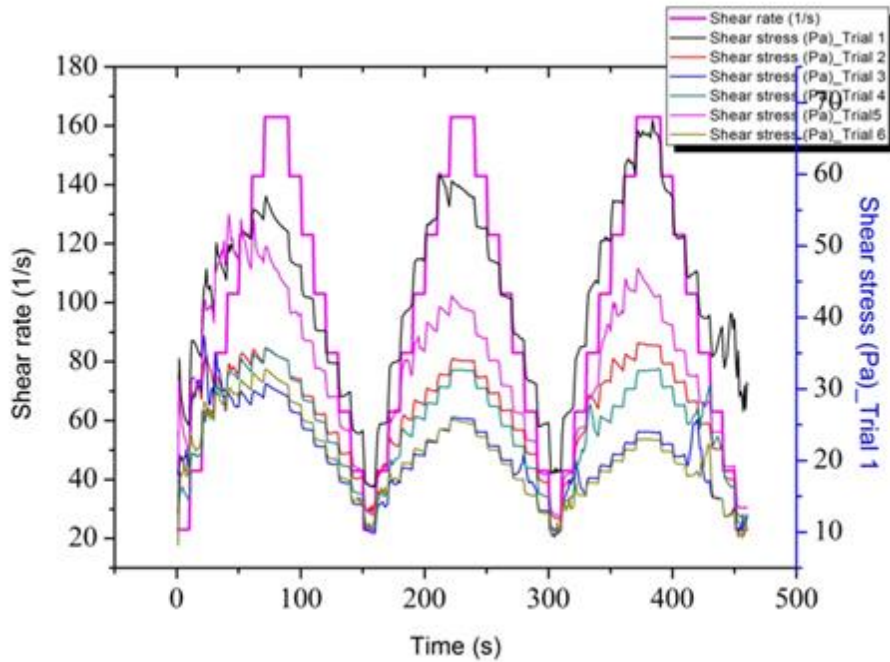

Figure 5.7 Results for OPC-PCE combination without superplasticizer at 0.35 w/b ratio

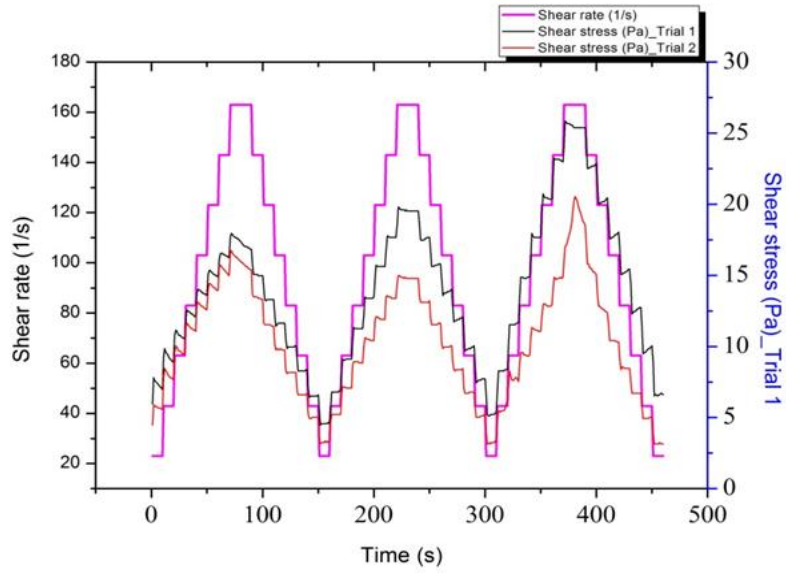

Figure 5.8 Results for OPC-PCE combination at lower than saturation superplasticizer dosage and 0.40 w/b ratio

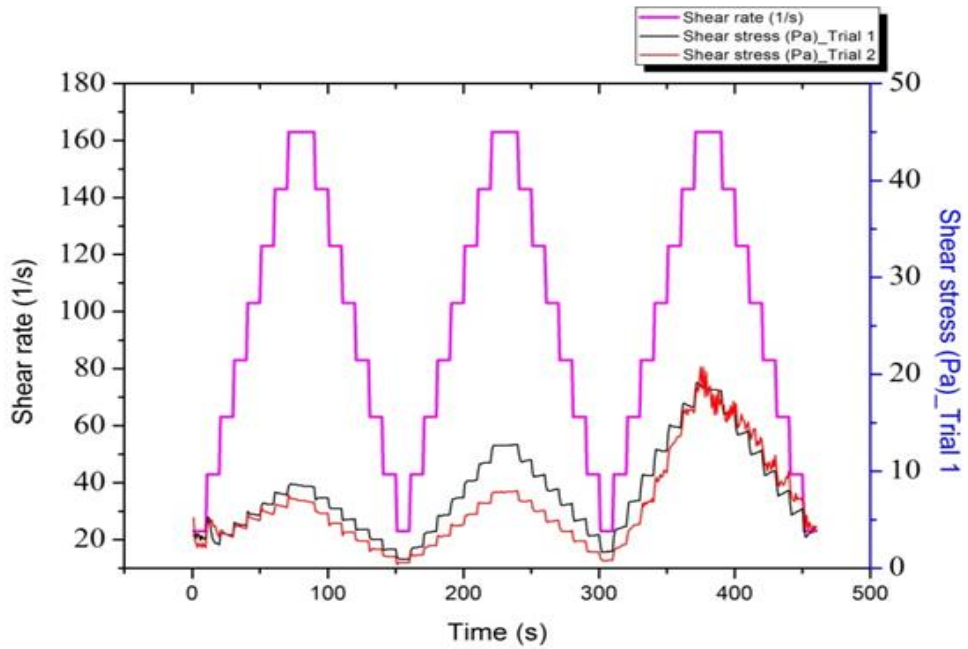

Figure 5.9 Results for OPC-PCE combination at saturation superplasticizer dosage and 0.40 w/b ratio

The protocol was modified even to two loading and unloading cycles. The results are shown in Figures 5.10 - 5.12 for OPC-PCE combination with no superplasticizer, lower than saturation, and saturation superplasticizer dosages at 0.40 w/b ratios. Here also, there was no repeatability and large scatter of data.

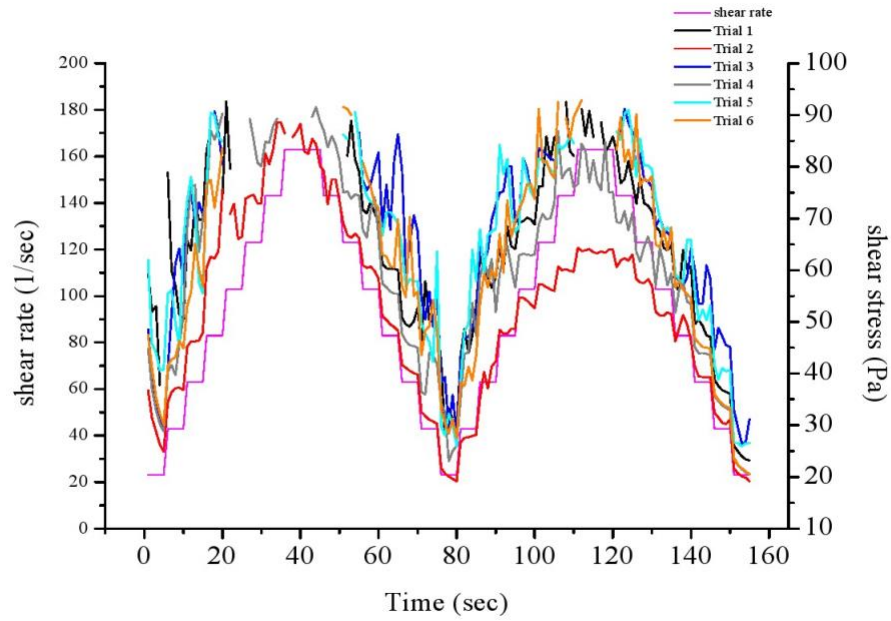

Figure 5.10 Results for OPC-PCE combination without superplasticizer dosage and 0.40 w/b ratio

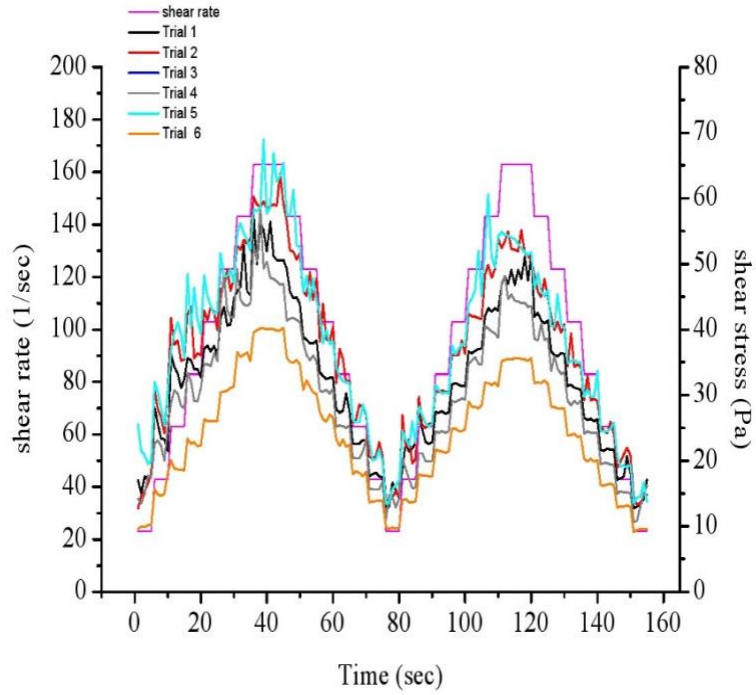

Figure 5.11 Results for OPC-PCE combination at lower than saturation superplasticizer dosage and 0.40 w/b ratio

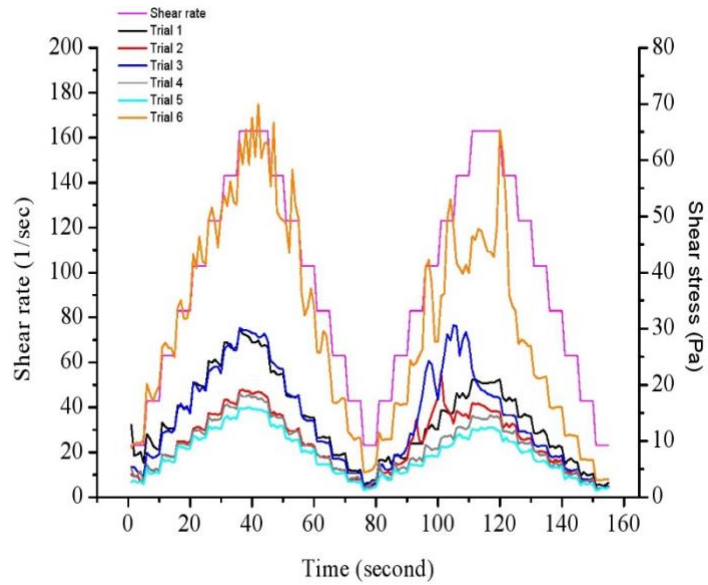

Figure 5.12 Results for OPC-PCE combination at saturation superplasticizer dosage and 0.40 w/b ratio

Another issue was that the torque required for LC³ systems with lower w/c ratio exceeded the instrument capacity. Hence, to resolve this issue, another spindle with a smaller diameter and length was chosen (SC4 -25 with 17.70 mm effective length and 4.78 mm diameter). This is because a spindle with smaller length and diameter can produce the same shear stress in the fluid with comparatively lower torque. The results with S4-25 are shown in Figure 5.13.

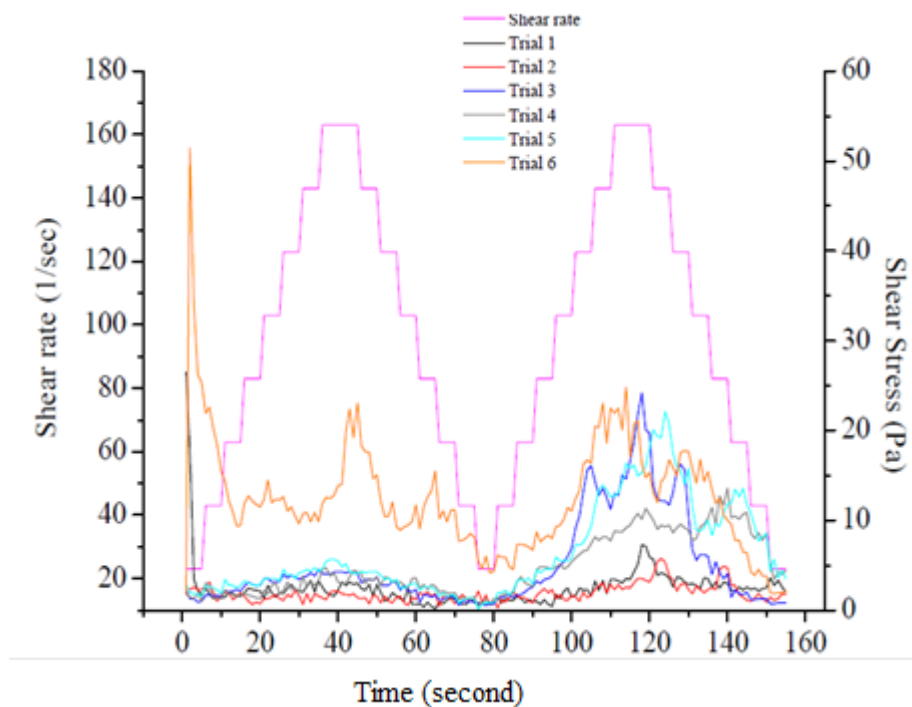

Figure 5.13 Results for OPC-PCE combination at saturation superplasticizer dosage and 0.40 w/b ratio, with reduced spindle diameter

Even with the new spindle, the torque required for LC³ system at low w/b ratio exceeded the instrument capacity. Also, with the smaller spindle, the torque was less than the minimum instrument capacity for OPC with higher w/c ratio. Therefore, with the co-axial setup, it was not possible to perform the testing of all samples by keeping the torque value

within the instrument capacity. Another major issue was the presence of noise in the data and lack of repeatability for all samples. This may indicate the occurrence of wall slip at the boundaries. Hence, to prevent wall slip and to keep the torque values for all samples within the instrument capacity, the vane geometry was chosen. The tests performed with this geometry are explained in the next section.

5.3.4 Test method using vane shear

The Vane geometry shown in Figure 5.14 was used in an attempt to rectify the issue faced with the coaxial cylinder geometry. The spindle size was selected based on trials which satisfied the torque criteria as mentioned before. Table 5.1 shows the different vane spindles available. From this, V-71 satisfied the torque requirement and a protocol was developed based on this. This protocol was selected based on trials satisfying the torque requirements for all the three blends, and is shown in Figure 5.15. The rotation speed was increased from 4 rpm to 10 rpm in steps and then ramped down, maintaining 20 seconds for each step. Three trials were done for all the combinations of binder and admixture at different w/b ratios and repeatability was observed. The data from the downward ramp was used for the assessment. The output from the software is the torque (expressed in percentage with respect to the maximum torque capacity of the instrument) and viscosity. From the test setup, only the viscosity data can be relayed and used for assessing the paste behaviour at saturation dosage. There is no valid conversion factor in this setup for the conversion of torque in percentage to shear stress. Therefore, the results are shown with respect to viscosity v/s speed in rpm. The viscosity is calculated by the instrument based on the assumption of a Couette flow when the applied angular velocity is below 10 rpm.



Figure 5.14 Brookfield viscometer with vane test setup (Asphalt Laboratory, IITM)

Table 5.1 Vane dimensions

Spindle	Vane length (cm)	Vane diameter (cm)
V71	6.878	3.439
V72	4.338	2.167
V73	2.535	1.267
V74	1.176	0.589

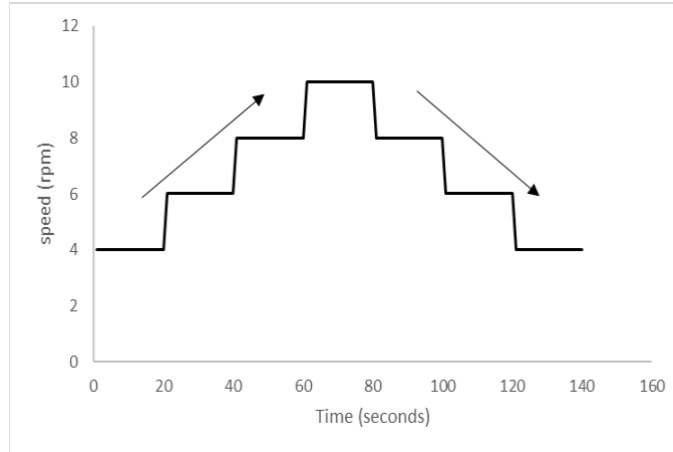

Figure 5.15 Shear history of rheological testing with vane spindle

5.4 RESULTS AND DISCUSSION

Figure 5.16 and Figure 5.17 shows the variation of viscosity with speed at saturation dosage of PCE for the different binders at w/b ratios of 0.35 and 0.40, respectively. The viscosity is observed to reduce with increase in w/b ratio. For w/b ratio 0.35, OPC and FA30 exhibited shear-thinning behaviour, whereas LC³ also exhibited a shear thinning behaviour but not to the extent of OPC and FA30 at saturation dosage. This is due to due to its highly cohesive nature of LC³, which could be attributed to its high fineness. The viscosity of FA30 is low compared to OPC and LC³ for w/b ratio 0.35 at saturation dosage. As the w/b ratio increased from 0.35 to 0.40, the flow behaviour of LC³ showed shear- thinning behaviour similar to OPC and FA30. On the other hand, the viscosity of LC³ and FA30 reduce with speed and these binders follow similar pattern as the lower w/b at their corresponding saturation dosages. The viscosity of FA30 system is even lesser than OPC for both the blends. It has to be noted that for LC³ systems there is a significant change in the flow behaviour when the w/b ratio is less than 0.40. While the viscosity is mostly

significantly higher than OPC at the lower w/b, there is a considerable reduction below OPC for the higher w/b.

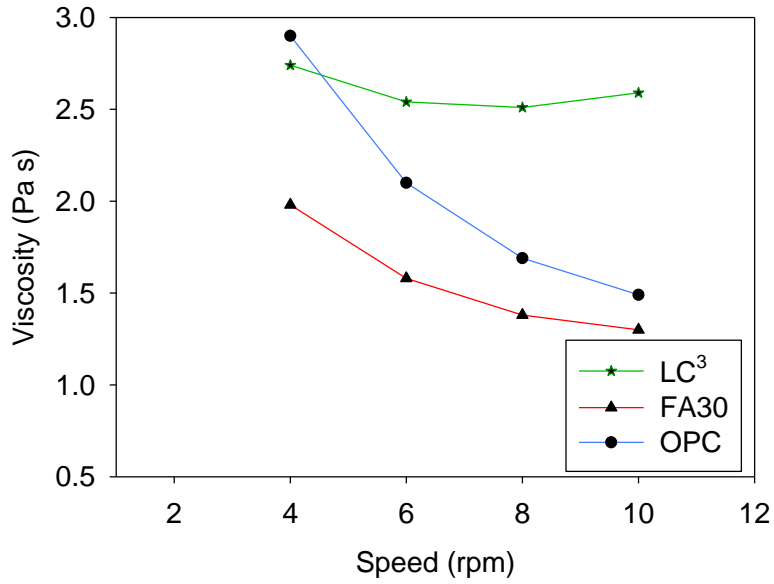

Figure 5.16 Viscosity at saturation dosages of PCE for binders at w/b ratio 0.35

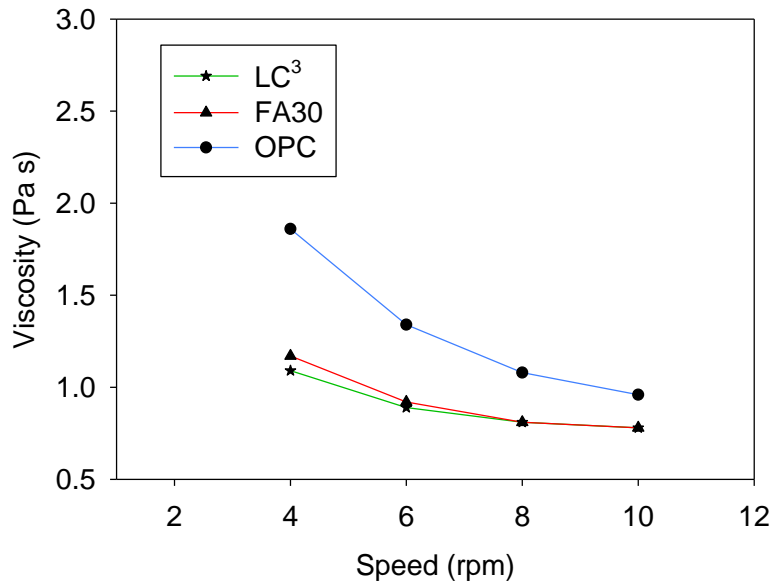

Figure 5.17 Viscosity at saturation dosages of PCE for binders at w/c ratio 0.40

Figure 5.18 and Figure 5.19 show the variation of viscosity with speed at saturation dosage of SNF with different binders for w/b ratios of 0.35 and 0.40, respectively. There are notable differences in the viscosity range of binders with SNF and PCE admixtures. Even at saturation dosage, the viscosity is greater for all the systems with SNF compared to that of binders with PCE. The flow behaviour at low w/b ratio had a similar trend as in the case of PCE admixtures. LC³ showed shear thinning behaviour for w/b ratio 0.35 at saturation dosage not to the extent of OPC and FA30. The viscosity of FA30 was lower compared to OPC and LC³ for 0.35 w/b ratio at saturation dosage. When the w/b ratio increased from 0.35 to 0.40, the flow behaviour of LC³ showed shear thinning behaviour similar to OPC and FA30. Unlike the trend shown with PCE admixture, here even at w/b ratio 0.40 the viscosity of LC³ was higher compared to OPC and FA30. The reason for higher viscosity may be because the range of angular velocity used in the study is from 4-10 rpm. The viscosity for OPC and FA30 reported in the literature are usually with measurements at relatively higher angular velocities.

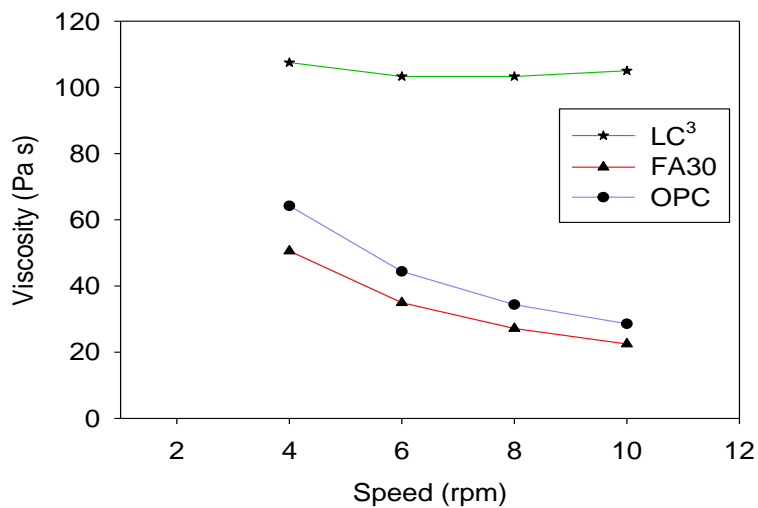

Figure 5.18 Viscosity at saturation dosage of SNF for binders at w/b ratio 0.35

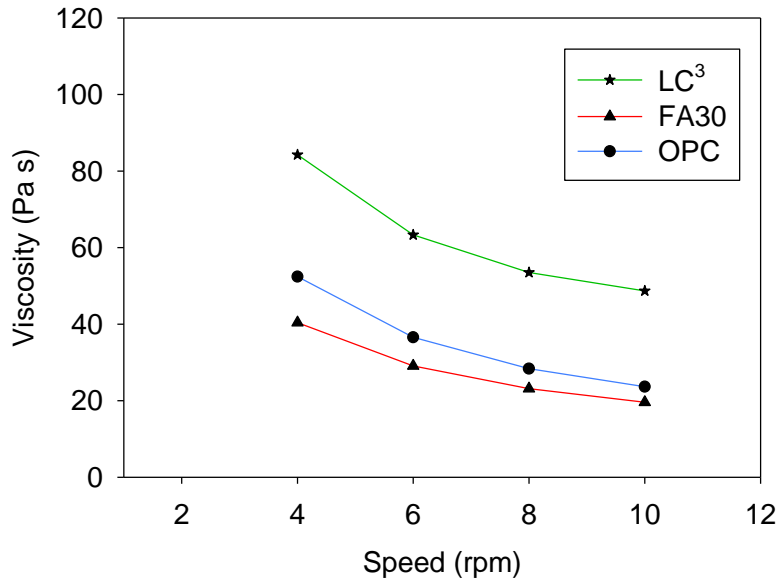

Figure 5.19 Viscosity at saturation dosage of SNF for binders at w/b ratio 0.40

5.5 SUMMARY

In this chapter, the flow behaviour of LC³, OPC and FA30 were studied for w/b ratio 0.35 and 0.40 at their corresponding saturation dosages of the superplasticizers. Comparing the flow behaviour of blends using PCE admixture at saturation dosage and w/b ratio 0.35, LC³ showed shear thinning behaviour but not to the extent of OPC and FA30 at saturation dosage. For w/b ratio of 0.40, all the binder systems showed shear-thinning behaviour. The viscosity of LC³ was similar to FA30 at the higher w/b and less compared to OPC. Similarly, for the combination of cement-SNF, at w/b ratio 0.35, LC³ showed shear thinning behaviour not to the extent of OPC and FA30 at saturation dosage. For 0.40 w/b ratio, LC³, OPC and FA30 showed shear-thinning behaviour. The viscosity of LC³ was higher compared to OPC and FA30. It has to be noted that w/b ratio has significant influence on the flow behaviour of LC³ systems. The combination of LC³-PCE showed better performance in terms of rheology compared to LC³-SNF combination. The next

chapter discusses the performance of LC³ concrete with superplasticizers in fresh and hardened state.

CHAPTER 6

LC³ – FRESH AND HARDENED CONCRETE

6.1 INTRODUCTION

The water-to-binder ratio and type and amount of superplasticizer affects the workability of concrete. The dosage of superplasticizer required in concrete can be decided by using methods like slump test. However, an alternative procedure is to determine the saturation dosage for the corresponding binder by using a Marsh cone or a viscometer, as described in the earlier chapters. This result can be correlated with the SP requirement for concrete. In this chapter, a comparison is done between the saturation dosage obtained from the LC³ paste study with the dosage required for LC³ concrete in order to achieve a target slump of 180-200 mm. The corresponding hardened properties of the concrete are also measured.

6.2 EXPERIMENTAL DETAILS

6.2.1 Preparation of concrete

The concrete was prepared using mechanical batch mixer having two blades and fitted with power loader (lifting hopper type). The properties of the materials used were discussed in Chapter 3. First the measured quantity of coarse aggregate and fine aggregate were mixed together. The cement was then added and mixed to get a homogeneous dry mixture. The subsequent mixing sequence of addition of water and superplasticizer were same as that for paste.

6.2.2 Mix proportions

LC³ concrete studies were done for a fixed binder content and w/b ratio to attain high workability i.e. slump of 180-200 mm. The aggregate proportion and superplasticizer dosages were fixed based on the target slump.

The combinations of cement content and w/b ratio used to design the concrete mixes are as follows:

- 300 kg/m³ and w/b ratio = 0.60
- 350 kg/m³ and w/b ratio = 0.50
- 400 kg /m³ and w/b ratio = 0.40
- 450 kg/m³ and w/b ratio = 0.30

The first trial was done for the binder content 300 kg/m³, aggregate proportion 60:40 (coarse aggregate: fine aggregate) and w/b ratio 0.60. In the paste studies, the w/b ratio was limited to 0.35, 0.40 and 0.45. Therefore, in order to compare the superplasticizer requirement for concrete with that of paste studies, the saturation dosages for w/b ratios 0.30, 0.50 and 0.60 were also found on paste mixes. This was done only for the LC³ cement. For w/b ratio of 0.6 the saturation dosage obtained for LC³ cement pastes was 0.05% using PCE based admixture. However, in concrete, even when the superplasticizer dosage was increased by 50 % of the saturation dosage for the paste, the mix was very stiff and zero slump was obtained. This indicates that the LC³ concrete mixes had a large demand of superplasticizer to achieve high workability. Trials were repeated with increasing dosages of superplasticizer, but the maximum slump that could be attained was only 70 mm. Further

addition of PCE caused bleeding issues. After multiple number of trials the aggregate ratio was fixed as 50:50 (coarse aggregate: fine aggregate), and the resultant mix had a slump of 190 mm for superplasticizer dosage of 0.65 % by weight of cement. The aggregate ratio was then fixed at 50:50 (coarse aggregate: fine aggregate) for all the mixes. The tests done for evaluating the fresh and hardened properties are shown in Table 6.1.

Table 6.1 Tests done for determining the fresh and hardened properties of LC³ concrete

Property	Tests done	Code referred	Specimen size
Workability	Slump test	IS 1199-2004	----
Hardened property	Compressive strength	IS 516-2004	100 × 100 × 100 mm
	Split Tensile strength	IS 516-2004	100 × 200 mm Cylinder
	Flexural strength	IS 516-2004	500 × 100 × 100 mm

6.3 RESULTS AND DISCUSSIONS

The details of the trials performed to attain the target slump using PCE are summarized in Table 6.2. The results showed that for all the mixes, the superplasticizer requirement was significantly higher than the saturation dosage obtained from paste studies for a corresponding w/b ratio. Similar to paste studies, the superplasticizer requirement reduced with increase in w/b ratio.

For a reduction of the w/b ratio from 0.60 to 0.40, there is not much variation in the superplasticizer requirement. When the w/b ratio is reduced below 0.40, a sudden increase in demand for superplasticizer is noted. This can be related to the viscometric studies described in Chapter 5, where the behaviour of LC³ paste changed when the w/b ratio was reduced from 0.40 to 0.30.

Table 6.3 illustrates the superplasticizer requirement for LC³ concrete using SNF based admixture. The coarse-fine aggregate proportion was fixed as 50:50. The requirement of SNF to achieve the target slump was significantly higher compared to PCE. At w/b ratio of 0.30 and 450 kg/m³ binder content, the superplasticizer dosage was even greater than 1.6 % by weight of cement and the target slump was not achieved. Therefore, the LC³ – SNF combination for w/b ratio below 0.40 was deemed not compatible.

From the slump tests, it can be concluded that PCE based admixture is better suited for LC³ systems as compared to SNF.

Table 6.2 Summary of tests done to attain the target slump using PCE

Binder content (kg/m ³)	w/b ratio	Aggregate ratio	sp/c %	Slump (mm)
300	0.60	60:40	0.40	No slump
		60:40	0.50	70
		60:40	0.60	Bleeding
		50:50	0.50	80
		50:50	0.60	115
		50:50	0.65	190
		50:50	0.70	Bleeding
350	0.50	50:50	0.50	No slump
			0.60	50
			0.65	185
			0.70	Bleeding
400	0.40	50:50	0.60	60
			0.65	150
			0.70	190
450	0.30	50:50	0.60	No slump
			0.70	No slump
			0.90	50
			1.20	200
			1.30	Bleeding

Table 6.3 Summary of tests done to attain the target slump using SNF

Binder content (kg/m ³)	w/b ratio	Aggregate ratio	sp/c %	Slump (mm)
300	0.6	50:50	0.8	60
			1.0	200
			1.1	Bleeding
350	0.5	50:50	0.9	110
			1.0	195
			1.1	Bleeding
400	0.4	50:50	1.0	0
			1.1	180
			1.3	195
			1.4	Bleeding
450	0.3	50:50	1.3	0
			1.6	80
			Superplasticizer requirement is greater than 1.6 %; incompatible	

Since the SP required to get the target slump was less using PCE admixture compared to SNF with LC³, further workability studies were done using PCE based admixture. In both paste and concrete studies, it was observed that for LC³ when the w/b ratio was reduced below 0.40, there was a sudden increase in the requirement of superplasticizer. The correlation between saturation superplasticizer dosage of paste and dosage required to achieve the target slump in concrete for the mixes is shown in Figure 6.1. In order to validate this, two additional mixes (370 kg/m³, w/b ratio 0.45 and 420 kg/m³, w/b ratio

0.35) were also tested. The mix proportions are listed in Table 6.4. Three trials were performed for each mix.

Table 6.4 Summary of concrete mix proportions

MIX I.D.	Binder content (kg/m ³)	Water content (kg/m ³)	w/b ratio
MIX 1	300	180	0.6
MIX 2	350	175	0.5
MIX 3	370	167	0.45
MIX 4	400	160	0.40
MIX 5	420	147	0.35
MIX 6	450	135	0.30

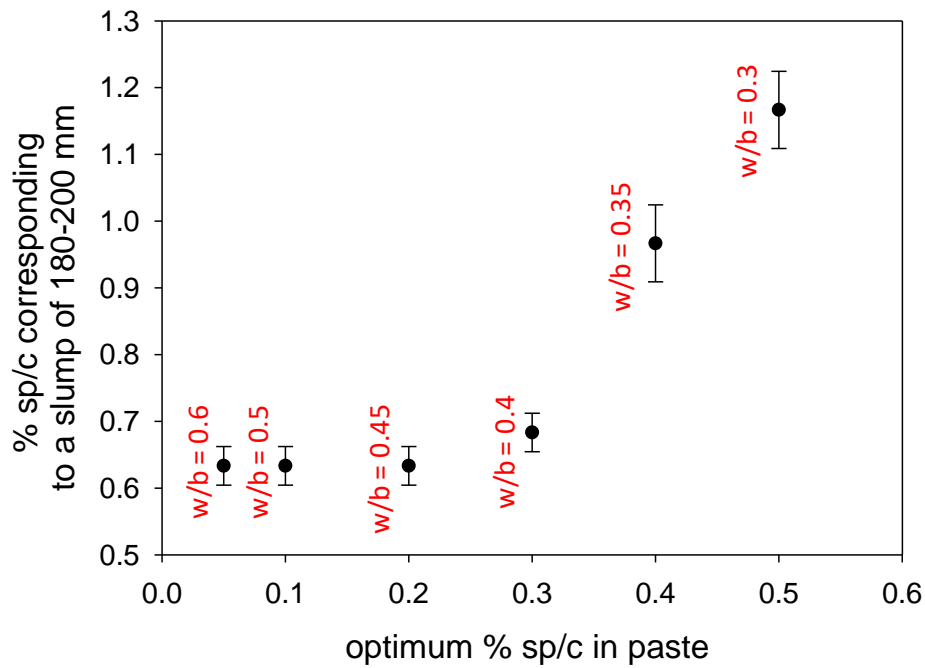

Figure 6.1 Correlating saturation dosage of PCE superplasticizer from paste studies with the finalized dosages from concrete

In order to understand the influence of water content reduction with respect to the superplasticizer dosage, the variation in water content and SP requirement for each mix was plotted as shown in Figure 6.2. It can be seen that for a reduction in water content from 180 kg/m³ (MIX 1) up to 166.5 kg/m³ (MIX 3), there was no significant change in the SP dosage required to produce the target workability. However, beyond 166.5 kg/m³ (i.e. for MIX 4, MIX 5 and MIX 6), the SP dosage required increased significantly with the reduction in water content.

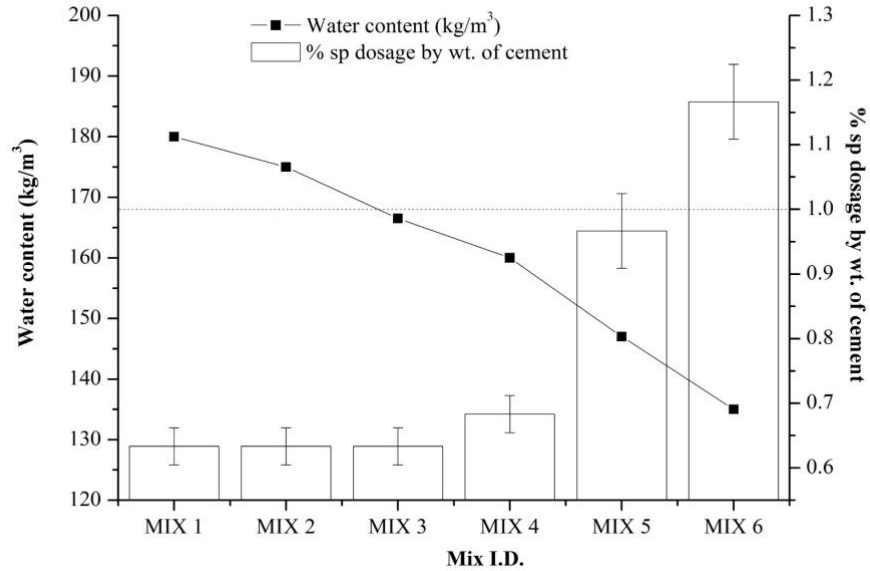

Figure 6.2 Water content and SP dosage requirement for each mix

The slump was measured after 60 minutes from the initial mixing of concrete, to understand the retention capability of LC³ systems using both the admixtures. The results are shown in Table 6.5 and Table 6.6 for PCE and SNF respectively. The decrease of slump with time due to the presence of metakaolin for a given w/b ratio has been reported in literature

(Perlot et al. 2013). It is clear from the results that even though it was possible to attain a high workability in the initial state, the retention was very poor for LC³ systems.

Table 6.5 Slump retention of LC³ concrete using PCE admixture

Binder content (kg/m ³).	w/b ratio	Aggregate ratio	Sp/c %	Slump (mm)	
				Initial	60 minutes
300	0.6	50:50	0.65	190	35
350	0.5	50:50	0.65	185	10
400	0.4	50:50	0.70	190	0
450	0.3	50:50	1.20	200	0

Table 6.6 Slump retention of LC³ concrete using SNF admixture

Binder content (kg/m ³).	w/b ratio	Aggregate ratio	Sp/c %	Slump (mm)	
				Initial	Initial
300	0.6	50:50	1.00	200	20
350	0.5	50:50	1.00	195	0
400	0.4	50:50	1.30	195	0

The hardened properties such as compressive strength, tensile and flexural strength of LC³ concrete evaluated at 7 and 28 days on an average of three specimens each. Table 6.7 shows the strength results of LC³-PCE combination system and Table 6.8 shows the strength results of LC³-SNF combination system. For all the mixes tested, LC³-PCE combination showed better 7 and 28 day compressive, tensile and flexure strengths as compared to LC³-SNF combination. Therefore, the combination of LC³-PCE proved better in hardened properties as opposed to LC³-SNF combination.

Table 6.7 Summary of hardened properties using LC³-PCE combination

Binder content (kg/m ³)	Hardened properties					
	Compressive strength (MPa)		Tensile strength (MPa)		Flexural strength (MPa)	
	7 th day	28 th day	7 th day	28 th day	7 th day	28 th day
300	23.10(±1.12)	29.27(±0.78)	1.78(±0.22)	2.40(±0.07)	4.10(±0.07)	5.6(±0.20)
350	29.54(±0.54)	35.05(±0.34)	2.14(±0.46)	3.27(±0.17)	5.19(±0.12)	5.83(±0.28)
400	39.21(±0.35)	44.66(±1.18)	3.69(±0.47)	3.77(±0.35)	6.91(±0.36)	8.06(±0.65)
450	45.37(±2.31)	61.69(±2.21)	4.12(±0.12)	4.93(±0.41)	8.16(±0.95)	9.42(±0.14)

Table 6.8 Summary of hardened properties using LC³-SNF combination

Binder content (kg/m ³)	Hardened properties					
	Compressive strength (MPa)		Tensile strength (MPa)		Compressive strength (MPa)	
	7 th day	28 th day	7 th day	28 th day	7 th day	28 th day
300	17.21(±1.26)	26.09(±4.32)	1.69(±0.60)	2.34(±0.05)	3.47(±0.19)	4.58(±0.01)
350	24.92(±1.00)	32.08(±0.52)	1.95(±0.23)	2.85(±0.10)	3.65(±0.06)	5.54(±0.26)
400	28.71(±0.47)	40.71(±2.31)	2.13(±0.09)	2.96(±0.22)	4.95(±0.36)	7.62(±0.16)

6.4 SUMMARY

The performance of LC³ concrete in the fresh and hardened state was analyzed in this chapter. The w/b ratio was seen to have a significant influence on the workability of LC³ concrete systems. At w/b ratios lower than 0.40, very high dosage of superplasticizer was required to achieve the target slump. On the other hand, the mixes behaved differently

when the w/b was above 0.40. From this study, it can be concluded that with appropriate superplasticizer dosage and aggregate proportions, it is possible to produce LC³ concrete with the required workability level. However, the addition of a suitable retarder would be necessary for workability retention, which is poor for the LC³ concretes. The strength development results for the concrete mixes indicate that, it is possible to achieve different grades of LC³ concrete with high workability. The test results show that LC³ is best suited for normal and low strength concrete. For high strength concrete with low w/b ratios, the use of LC³ requires careful mix proportioning and assessment of compatibility issues with the given superplasticizer. Hence, a detailed rheological investigation of the LC³ system at lower w/b ratios is required, which can be pursued as an extension of this work.

CHAPTER 7

CONCLUSIONS

7.1 GENERAL CONCLUSIONS

The flow behaviour of paste and concrete with Limestone Calcined Clay cement i.e. LC³ with commercially available superplasticizers was studied in this work. The scope of this study covers comparison of flow characteristics of concrete prepared using LC³ with OPC and FA30 (OPC replaced with 30% fly ash) using Marsh cone and mini-slump tests. The saturation dosage from the paste studies and compatibility of PCE and SNF superplasticizers with the cementitious blends for different w/b ratios were also determined. The rheological characteristics of the blended systems with PCE and SNF superplasticizers at saturation dosage were studied. Finally, LC³ concrete mixes were designed at different binder content and water-to-binder ratio to attain high workability. The salient conclusions from the study are given below.

- Due to high fineness and intercalation of superplasticizer molecules between layers of clay, LC³ requires more superplasticizer to reach the saturation dosage compared to OPC and FA30. The flow time of LC³ through Marsh funnel was high at low w/b ratio whereas, when the w/b ratio was increased, the flow time of LC³ reduced and was comparable to that of FA30. Also, due to the differences in the basic mechanism of PCE and SNF based superplasticizers, the dosage to reach saturation was high for all the blends using SNF based superplasticizer. The results from the Marsh cone and mini-slump tests point out that LC³ systems were compatible with PCE based

superplasticizer. It was observed that at w/b ratio above 0.35, the Marsh cone flow curve and mini-slump spread of LC³ was similar to that of FA30.

- Understanding the rheology of LC³ system was complex. Due to its cohesive nature, it was difficult for the spindle to move in a rotational viscometer at low w/b ratios. The torque limitation of the instrument was another issue for running the instrument at high w/b ratio. Vane geometry was able to rectify these issues to a certain level. Within the limitations of the instrument capacity, the rheological behaviour was assessed. The significant influence of w/b ratio on LC³ systems was noted from the tests. The flow behaviour changed with respect to w/b ratios. This gave better understanding of the flow characteristics of LC³ than conventional tests methods such as Marsh cone and mini-slump in paste studies.
- The design of the mix proportions of LC³ concrete gave an insight of the applicability of LC³ in construction practices. It is possible to design LC³ concrete for target strength and workability requirements. As stated above, the dosage of superplasticizer for LC³ concrete to attain very high workability was high. With appropriate mixture proportioning and admixture dosages, it is possible to design LC³ concrete for low and normal strength concrete.

7.2 SPECIFIC CONCLUSIONS

- The maximum level of flow in LC³ is comparable to that of FA30. However, more superplasticizer is required for LC³ than FA30 and OPC. For PCE systems, the saturation dosage of superplasticizer for LC³ increased by 160 % and 200 % for w/b ratio 0.35 and 0.40 respectively w.r.t OPC systems. At 0.45 w/b ratio, no SP was required for OPC, whereas LC³ required 0.20 % SP for saturation flow in the Marsh cone.
- In the case of SNF systems, the saturation dosage of superplasticizer for LC³ was increased by 75 % and 100 % for w/b ratios 0.35 and 0.40 respectively w.r.t. OPC systems. Similar to PCE systems, at 0.45 w/b ratio, no SP was required for OPC, whereas LC³ required 0.30 % SP for saturation flow in the Marsh cone.
- LC³ has shear thinning behaviour at w/b ratio 0.40. However, at 0.35 w/b ratio LC³ showed shear thinning behaviour but not to the extent of OPC and FA30 using PCE and SNF at saturation dosage. Whereas, OPC and FA30 exhibited shear-thinning behaviour for both 0.35 and 0.40 w/b ratios.
- The viscosity of paste with LC³ is lower using PCE admixture than SNF admixture for all w/b ratios (at saturation dosage of superplasticizer).
- The superplasticizer requirement was significantly higher than the saturation dosage obtained from paste studies for all the w/b ratios used in the study. For w/b ratios from 0.60 to 0.40, the SP requirement was 0.65 % for PCE based admixture to maintain the target workability and there was not much variation in the superplasticizer requirement.

When the w/b ratio was reduced below 0.40, a sudden increase in demand for superplasticizer to 1.2 % was noted. The superplasticizer requirement for LC³ concrete using SNF based admixture to achieve the target slump was very high compared to PCE. At w/b ratio of 0.30 and 450 kg/m³ binder content, the superplasticizer dosage was even greater than 1.6 % by weight of cement and the target slump was not achieved. Therefore, the LC³ – SNF combination for w/b ratio below 0.40 was deemed not compatible.

- It was possible to produce concrete with LC³-PCE systems with 300, 350, 400 and 450 kg/m³ binder contents with a workability between 180-200 mm slump. However, the workability retention was found to be poor. The slump of concrete with 300 and 350 kg/m³ binder contents was reduced to 35 mm and 10 mm respectively after 60 minutes, whereas concrete with 400 and 450 kg/m³ binder contents showed zero slump after 60 minutes. For LC³-SNF combination, the slump was reduced to 20 mm after 60 minutes for the mix with 300 kg/m³ binder content and zero slump for the rest of the binder contents after 60 minutes.
- For w/b ratios 0.60, 0.50, and 0.40, the 7th day compressive strength was reduced by 25 %, 15 % and 26 % respectively for LC³-SNF combination compared to LC³-PCE combination. The reduced early strength of SNF systems may be due to higher SP dosage required to maintain same workability compared to PCE systems. For 28 days, the strength decrease was lower. The 28 day compressive strength was only reduced by 11 %, 8.5 %, and 8 % for w/b ratios 0.6, 0.5, and 0.40 respectively for LC³-SNF

combination compared to LC³-PCE combination. Therefore, the combination of LC³-PCE proved better in hardened properties as opposed to LC³-SNF combination.

- Since PCE required lower SP dosage and showed reduced strength loss at 7 and 28 days, it can be concluded that PCE showed better compatibility with LC³ systems for all the w/b ratios considered in the study.

7.3 RECOMMENDATIONS FOR FURTHER STUDIES

- In the present study, the rheological studies were performed in a viscometer. Due to the limitations of the instrument torque capacity, the speed is restricted to only 10 rpm. In actual practice, usually the viscosity is measured corresponding to a shear rate of 50 to 100 s⁻¹, selected based on field applications. Therefore, experimental studies on instruments like dynamic shear rheometer (DSR) with higher torque capacity can be done to understand the rheology of LC³ with superplasticizers at higher shear rates.
- The workability retention was studied for LC³ concrete. In order to understand the rate of adsorption of superplasticizers on LC³ and its effect on workability retention, studies can be carried out at the paste level using Infrared / UV-Vis Spectroscopy.
- For LC³ cements, the dosage required to attain high workability was more compared to ordinary cement. This may be due to high fineness and intercalation of SP molecules between clay layers. Studies can be done using modified forms of PCE based superplasticizers which may result in lesser intercalation and hence, reduced SP dosage for a given workability.

REFERENCES

- Aïtcin, P. C. and M. Baalbaki** (1994) Concrete admixtures – Key components of modern concrete. *Concrete Technology: New trends, Industrial applications*, E & FN Spon, London, 33-47.
- Aïtcin, P.C., C. Jolicoeur, J. MacGregor** (1994) Superplasticizers: How they work and why they occasionally don't. *Concrete International*, **16**, 45-52.
- Agullo, L., R. Gettu, and A. Aguado** (1999) Fluidity of cement pastes with mineral admixtures and superplasticizer- A study based on the Marsh cone test. *Materials and Structures*, **32**, 479–485.
- Alonso, M. M., Palacios, M., and F. Puertas** (2013) Compatibility between polycarboxylate-based admixtures and blended-cement pastes. *Cement and Concrete Composites*, **35**, 151–162.
- Alonso, M. M., M. Palacios, F. Puertas, A. G. de Torre, and M. A. G. Aranda** (2007) Effect of polycarboxylate admixture structure on cement paste rheology. *Materiales de Construcción*, **57**, 65–81.
- Alonso, M. M. and F. Puertas** (2015) Adsorption of PCE and PNS superplasticisers on cubic and orthorhombic C₃A. Effect of sulfate. *Construction and Building Materials*, **78**, 324–332.
- Anagnostopoulos, C. A., P. Kandiliotis, M. Lola, and S. Karavatos** (2014) Effect of different superplasticisers on the physical and mechanical properties of cement grouts. *Research Journal of Applied Sciences, Engineering and Technology*, **7**, 3478–3490.
- Antoni, M., J. Rossen, F. Martirena, and K. Scrivener** (2012a) Cement substitution by a combination of metakaolin and limestone. *Cement and Concrete Research*, **42**, 1579–1589.
- Antoni, M., J. Rossen, F. Martirena, and K. Scrivener** (2012b) Cement and Concrete Research Cement substitution by a combination of metakaolin and limestone. *Cement and Concrete Research*, **42**, 1579–1589.
- Antoni, M., J.** (2011) Investigation of cement substitution by combined addition of calcined clays and limestone. *Doctoral thesis*, École Polytechnique Fédérale De Lausanne, Lausanne.
- Atzeni, C., L. Massidda, and U. Sanna** (1985) Comparison between rheological models for Portland cement pastes. *Cement and Concrete research*, **15**, 511-519.

- Aydın, S., A. H. Aytaç, and K. Ramyar** (2009) Effects of fineness of cement on polynaphthalene sulfonate-based superplasticizer – cement interaction. *Construction and Building Materials*, **23**, 2402–2408.
- Batis, G., P. Pantazopoulou, S. Tsvivilis, E. Badogiannis** (2005) The effects of metakaolin on the corrosion behaviour of cement mortars. *Cement and Concrete Research*, **27**, 125–135.
- Bentz, D. P., C. F. Ferraris, M. A. Galler, A. S. Hansen, and J. M. Guynn** (2012) Influence of particle size distributions on yield stress and viscosity of cement – fly ash pastes. *Cement and Concrete Research*, **42**, 404–409.
- Bishnoi, S., S. Maity, A. Mallik, S. Joseph, and S. Krishnan** (2014) Pilot scale manufacture of limestone calcined clay cement: The Indian experience. *Indian Concrete Journal*, **88**, 22–28.
- Bonavetti, V. L., V. F. Rahhal, E. F. Irassar** (2001) Studies on the carboaluminate formation in limestone filler-blended cements. *Cement and Concrete Research*, **31**, 853–859.
- Burgos-montes, O., M. Palacios, P. Rivilla, and F. Puertas** (2012) Compatibility between superplasticizer admixtures and cements with mineral additions. *Construction and Building Materials*, **31**, 300–309.
- Burst, J. F.** (1991) The application of clay minerals in ceramics. *Applied Clay Science*, **5**, 421–443.
- Cassagnabère, F., P. Diederich, M. Mouret, G. Escadeillas, and M. Lachemi** (2013) Impact of metakaolin characteristics on the rheological properties of mortar in the fresh state. *Cement and Concrete Composites*, **37**, 95–107.
- Chandra, S. and J. Björnström** (2002) Influence of cement and superplasticizers type and dosage on the fluidity of cement mortars — Part I. *Cement and Concrete Research*, **32**, 1605–1611.
- Chindaprasirt, P., S. Hatanaka, T. Chareerat, N. Mishima, and Y. Yuasa** (2008) Cement paste characteristics and porous concrete properties. *Construction and Building Materials*, **22**, 894–901.
- Colleparidi, M.** (1998) Admixtures used to enhance placing characteristics of concrete. *Cement and Concrete Composites*, **20**, 103–112.
- Courard, L., F. Michel, and J. Pierard** (2011) Influence of clay in limestone fillers for self-compacting cement-based composites. *Construction and Building Materials*, **25**, 1356–1361.

Cravero, F., I. Gonzalez., E. Galan, and E. Dominguez (1997) Geology, mineralogy, origin and possible applications of some Argentinian kaolins in the Neuquen basin. *Applied Clay Science*, **12**, 27–42.

Díaz, Y. C., S. Sánchez Berriel, U. Heierli, A. R. Favier, Sánchez Machado, I. R., Scrivener, K. L., Martirena Hernández, J. F., and Habert, G. (2017) Limestone calcined clay cement as a low-carbon solution to meet expanding cement demand in emerging economies. *Development Engineering*, **2**, 82–91.

de Larrard, F. (1989) Ultrafine particles for the making of very high strength concretes. *Cement and Concrete Research*, **19**, 161–172.

de Larrard, F. (1990) A method for proportioning high strength concrete mixtures. *Cement, Concrete and Aggregates*, **12**, 47-52.

Elson John (2014) Effect of temperature and cement characteristics on cement-superplasticizer interaction. *Doctoral thesis*, Indian Institute of Technology Madras, Chennai.

Feldman, R. F., G. G. Carette, and V. M. Malhotra (1990) Studies on mechanics of development of physical and mechanical properties of high-volume fly ash-cement pastes. *Cement and Concrete Composites*, **12**, 245–251.

Felekoğlu, B., S. Türkel, and H. Kalyonçu (2009) Optimization of fineness to maximize the strength activity of high-calcium ground fly ash - portland cement composites. *Construction and Building Materials*, **23**, 2053–2061.

Fernandez, R., F. Martirena, and K. L. Scrivener, K. L. (2011) The origin of the pozzolanic activity of calcined clay minerals: A comparison between kaolinite, illite and montmorillonite. *Cement and Concrete Research*, **41**, 113–122.

Ferraris, C. F., K. H. Obla, and R. Hill (2001) The influence of mineral admixtures on the rheology of cement paste and concrete. *Cement and Concrete Research*, **31**, 245–255.

Flatt, R. J., and Y. F. Houst (2001) A simplified view on chemical effects perturbing the action of superplasticizers. *Cement and Concrete Research*, **31**, 1169–1176.

Gartner, E. (2004) Industrially interesting approaches to “low-CO₂” cements. *Cement and Concrete Research*, **34**, 1489–1498.

Gelardi, G., N. Sanson, G. Nagy, and R. J. Flatt (2017) Characterization of comb-shaped copolymers by Multidetector SEC, DLS and SANS. *Polymers*, 2017.

Giaccio, G., and R. Zerbino (2002) Optimum superplasticiser dosage for systems with different cementitious materials. *Indian Concrete Journal*, **76**, 553–557.

Gomes, P.C.C., R. Gettu, L. Agullo, and C. Bernard, Experimental optimization of high strength self-compacting concrete, pp. 377-386, **K. Ozawa, and M. Ouchi** (eds) Proceedings of *second International Symposium on SCC*, Kochi, Japan, 2001.

Gomes, P.C.C. (2002) Optimization and characterization of high strength self compacting concrete. *Doctoral thesis*, Universitat Politecnica De Catalunya, Barcelona, Spain.

Grim, R.E. (1968) *Clay mineralogy*, McGraw Hill publishing, New York (USA).

Habert, G., C. Billard, P. Rossi, C. Chen, and N. Roussel (2010) Cement production technology improvement compared to factor 4 objectives. *Cement and Concrete Research*, **40**, 820–826.

Habert, G., J. B. d’Espinoze de Lacaillerie, and N. Roussel (2011) An environmental evaluation of geopolymer based concrete production: Reviewing current research trends. *Journal of Cleaner Production*, **19**, 1229–1238.

Hackley, A. Vincent, and C. F. Ferraris (2001) The use of nomenclature in dispersion science and Technology, **960**, *US. Department of Commerce, technology Administration*, National Institute of Standards and Technology.

Hallal, A., E. H. Kadri, K. Ezziane, A. Kadri, and H. Khelafi (2010) Combined effect of mineral admixtures with superplasticizers on the fluidity of the blended cement paste. *Construction and Building Materials*, **24**, 1418–1423.

Hanehara, S. and K. Yamada (1999) Interaction between cement and chemical admixture from the point of cement hydration, absorption behaviour of admixture, and paste rheology. *Cement and Concrete Research*, **29**, 1159–1165.

Hendriks, C. A., E Worrell, L. Price, N. martin, L. Ozawa Meida, D. de Jager, and P. Riemer (2002) Emission reduction of greenhouse gases from the cement industry. Proceedings of the *4th International Conference on Greenhouse Gas control Technologies*, Austria (1998).

Hernandez, J. F. M. and K. Scrivener (2015) Development and Introduction of a Low Clinker, Low Carbon, Ternary Blend Cement in Cuba. *Calcined Clays for Sustainable Concrete*, RILEM Bookseries **10**, 323-329.

Huntzinger, D. N. and T. D. Eatmon (2009) A life-cycle assessment of Portland cement manufacturing: comparing the traditional process with alternative technologies. *Journal of Cleaner Production*, **17**, 668–675.

International Energy Agency, World Business council for Sustainable Development Cement Technology Roadmap 2009: Carbon Emission Reductions up to 2050.

IS 383 (2016) Indian standard specification for coarse and fine aggregates from natural sources for concrete. *Bureau of Indian Standards*, New Delhi.

IS-456 (2000) Indian standard for Plain and Reinforced Concrete-Code of Practice. Bureau of Indian Standards, New Delhi.

IS 1199 (2004) Indian standard specification for methods of sampling and analysis of concrete. Bureau of Indian Standards, New Delhi.

IS 516 (2004) Indian standard specification for Methods of tests for strength of concrete. *Bureau of Indian Standards*, New Delhi.

IS 2386 (2007) Indian standard specification for methods of test for aggregates of concrete. *Bureau of Indian standards*, New Delhi.

IS 3812-1 (2003) Indian standard specification for Pulverized fuel ash, part 1: For use as pozzolana in cement, cement mortar and concrete. *Bureau of Indian standards*, New Delhi.

IS 9103 (2004) Indian standard specification for Concrete Admixtures. *Bureau of Indian standards*, New Delhi.

IS 12269 (2009) Indian standard specification for 53 grade ordinary Portland cement. *bureau of Indian standards*, New Delhi.

Jayasree, C. and R. Gettu (2008) Experimental study of the flow behavior of superplasticized cement paste. *Materials and Structures*, **41**, 1581-1593.

Jayasree, C. (2009) Study of cement-superplasticizer interaction and its implications for concrete performance. *Doctoral thesis*, Indian Institute of Technology Madras, Chennai.

Joshi, R. C. and T. S. Nagaraj (1991) Generalization of flow behavior of cement fly-ash pastes and mortars, *Journal of Materials in Civil Engineering*, **2**, 128–135.

Jones, T. E. R. and S. Taylor (1977) A mathematical model relating the flow curve of a cement paste to its water/cement ratio. *Magazine of Concrete Research*, **29**, 207-212.

Jeknavorian, A. A., L. Jardine, C.C. Ou, H. Koyata, K. J. Folliard (2003) Interaction of superplasticizers with clay-bearing aggregates, in. **V. M. Malhotra** (ed.), 7th CANMET/ACI *International Conference on Superplasticizers and Other Chemical Admixtures in Concrete*, Berlin/Germany, ACI, SP-217, 1293-1316.

Kantro, D.L. (1980) Influence of water-reducing admixtures on properties of cement paste-A miniature slump test. *Cement, Concrete and Aggregates*, **2**, 95-102.

Kim, B., S. Jiang, C. Jolicoeur, and P. C. Aïtcin (2000) The adsorption behavior of PNS superplasticizer and its relation to fluidity of cement paste. *Cement and Concrete Research*, **30**, 887–893.

Kirby, G. H. and J. A. Lewis (2004) Comb polymer architecture effects on the rheological property evolution of concentrated cement suspensions. *Journal of American Ceramic Society*, **87**, 1643 – 1652.

Kondraivendhan, B. and B. Bhattacharjee (2015) Flow behavior and strength for fly ash blended cement paste and mortar. *International Journal of Sustainable Built Environment*, The Gulf Organisation for Research and Development, **4**, 270–277.

Krishnan, S., A. C. Emmanuel, and S. Bishnoi (2015) Effective Clinker Replacement Using SCM in Low Clinker Cements. *Calcined Clays for Sustainable Concrete*, RILEM, pp 517–521.

Lei, L. and J. Plank (2012) A concept for a polycarboxylate superplasticizer possessing enhanced clay tolerance. *Cement and Concrete Research*, **42**, 1299–1306.

Li, C. Z., N. Q. Feng, Y. de Li, and R. J. Chen (2005) Effects of polyethylene oxide chains on the performance of polycarboxylate-type water-reducers. *Cement and Concrete Research*, **35**, 867–873.

Li, G. and X. Wu (2005) Influence of fly ash and its mean particle size on certain engineering properties of cement composite mortars. *Cement and Concrete Research*, **35**, 1128–1134.

Liu, S., X. Mo, C. Zhang, D. Sun, C. Mu (2004) Swelling inhibition by polyglycols in montmorillonite dispersions. *Journal of Dispersion Science Technology*, **25**, 63-66.

Maeder, U. and I. Schober (2003) Performance of blends of polycarboxylate polymers in different cements. *XI ICCO (Durban)*, South Africa, 504 – 513.

Magarotto, R., I. Torresan, N. Zeminian (2003) Effect of alkaline sulphates on the performance of superplasticizers. *In: 11th International Conference on the chemistry of cement*, 563-579.

Manning, D. (2007) Handbook of clay science (developments in clay science, 1), *Elsevier's science & Technology*.

Mehdipour, I., A. Kumar, and K. H. Khayat (2017) Rheology, hydration, and strength evolution of interground limestone cement containing PCE dispersant and high volume supplementary cementitious materials. *Materials & Design*, **127**, 54–66.

Mehta, P. K. and P. J. M. Monteiro (2006) *Concrete – Microstructure, Properties and Materials*, third ed., McGraw Hill, New York, 2006.

Mikanovic, N. and C. Jolicoeur (2008) Influence of superplasticizers on the rheology and stability of limestone and cement pastes. *Cement and Concrete Research*, **38**, 907–919.

- Mollah, MYA., WJ Adams, R Schennach, and DL Cocke** (2000) A review of cement–superplasticizer interactions and their models. *Advanced Cement Research*, **12**, 153–61.
- Murat, M.** (1983) Hydration reaction and hardening of calcined clays and related minerals. II. Influence of mineralogical properties of the raw-kaolinite on the reactivity of metakaolinite. *Cement and Concrete Research*, **13**, 511–518.
- Murray, H. H.** (1991) Overview - clay mineral applications. *Applied Clay Science*, **5**, 379–395.
- Murray, H. H.** (2000) Traditional and new applications for kaolin, smectite, and palygorskite: a general overview. *Applied Clay Science*, **17**, 207–221.
- Nawa, T., H. Ichiboji, M. Kinoshita** (2000) Influence of temperature on fluidity of cement paste containing superplasticizer with polyethylene oxide graft chains. In: *6th CANMET/ACI International Conference on Superplasticizers and other Chemical admixtures in Concrete*, Nice, 195-210.
- Nehdi, M. L.** (2014) Clay in cement-based materials: critical overview of state-of-the-art. *Construction and Building Materials*, **51**, 372–382.
- Nehdi, M., S. Mindess, and P. C. Aïtcin** (1996) Optimization of high strength limestone filler cement mortars. *Cement and Concrete Research*, **26**, 883–893.
- Neville, A. and P. C. Aïtcin** (1998) High performance concrete- an overview. *Materials and Structures*, **31**, 111–117.
- Newman, A. C.** *Chemistry of clays and clay minerals*. Longman Scientific & Technical, 1987.
- Ng, S. and J. Plank** (2012) Interaction mechanisms between Na montmorillonite clay and MPEG-based polycarboxylate superplasticizers. *Cement and Concrete Research*, **42**, 847–854.
- Nguyen, V. H., S. Rémond, J. L. Gallias, J. P. Bigas, and P. Muller** (2006) Flow of Herschel – Bulkley fluids through the Marsh cone. *Journal of Non-Newtonian Fluid Mechanics*. **139**, 128–134.
- Ohta, A., T. Sugiyama, Y. Tanaka** (1997) Fluidizing mechanism and application of polycarboxylate-based superplasticizers. In: *5th CANMET/ACI*, **173**, 359-378.
- Paiva, V. H., A. Velosa, P. Cachim, V. M. Ferreira** (2012) Effect of metakaolin dispersion on the fresh and hardened state properties of concrete. *Cement and Concrete Research*, **42**, 607-612.

- Papadakis, V. G.** (1999) Effect of fly ash on Portland cement systems: Part I. Low-calcium fly ash. *Cement and Concrete Research*, **29**, 1727–1736.
- Papo, A.** (1988) Rheological models for cement pastes. *Materials and Structures*, **21**, 41–46.
- Papo, A. and L. Piani** (2004) Effect of various superplasticizers on the rheological properties of Portland cement pastes. *Cement and Concrete Research*, **34**, 2097–2101.
- Park, C. K., M. H. Noh, and T. H. Park** (2005) Rheological properties of cementitious materials containing mineral admixtures. *Cement and Concrete Research*, **35**, 842–849.
- Parrot, L.** (2002) Cement and Concrete Sustainability. A report on the progress of the UK cement and concrete industry towards sustainability. *British Cement Association*.
- Perlot, C., P. Rougeau, and S. Dehaut** (2013) Slurry of metakaolin combined with limestone addition for self-compacted concrete. Application for precast industry. *Cement & Concrete Composites*, **44**, 50–57.
- Piotte, M., F. Bossfinyi, F. Perreault, and C. Jolicoeur** (1995) Characterization of poly(naphthalenesulfonate) salts by ion-pair chromatography and ultrafiltration. *Journal of Chromatography A*, **704**, 377–385.
- Plank, J., Z. Dai, N. Zouaoui, D. Vlad** (2006) Intercltion of polycarboxylate supeplasticizers into C₃A hydrate phases. In: *8th CANMET/ACI Superplasticizers and other Chemical Admixtures in Concrete*, Sorrento, Italia, 201-214.
- Plank, J. and M. Gretz** (2008) Study on the interaction between anionic and cationic latex particles and Portland cement. *Colloids and Surfaces A: Physicochemical and Engineering Aspects*, **330**, 227–233.
- Plank, J. and C. Hirsch** (2007) Impact of zeta potential of early cement hydration phases on superplasticizer adsorption. *Cement and Concrete Research*, **37**, 537–542.
- Poon, C., L. Lam, S. C. Kou, Y. Wong, and R. Wong** (2001) Rate of pozzolanic reaction of metakaolin in high-performance cement pastes. *Cement and Concrete Research*, **31**, 1301–1306.
- Pourchet, S., C. Comparet, L. Nicoleau, and A. Nonat** (2007) Influence of polycarboxylate superplasticizers on tricalcium silicate hydration, *Proceedings of the 12th International Congress on the Chemistry of Cement*, (Montréal, Canada) pp. 132–145.
- Prasad, M. S., K. J. Reid, and H. H. Murray** (1991) Kaolin: processing, properties and applications. *Applied Clay Science*, **6**, 87–119.

Ramachandran, V. S. (1988) Superplasticizers properties and applications in concrete. Ottawa: Materials Technology Laboratory, CANMET.

Ramezaniapour, A. A., E. Ghasvand, I. Nickseresht, M. Mahdikhani, and F. Moodi (2009) Influence of various amounts of limestone powder on performance of Portland limestone cement concretes. *Cement and Concrete Composites*, **31**, 715–720.

Rixom, R. and N. Mailvaganam (1999) *Chemical Admixtures for Concrete*, third ed., E & n Spon, London.

Rosković, R., and D. Bjegović (2005) Role of mineral additions in reducing CO₂emission. *Cement and Concrete Research*, **35**, 974–978.

Roussel, N. and R. Le Roy (2005) The Marsh cone: a test or a rheological apparatus? *Cement and Concrete Research*, **35**, 823–830.

Roussel, N., C. Stefani, and R. Leroy (2005) From mini-cone test to Abrams cone test: measurement of cement-based materials yield stress using slump tests. *Cement and Concrete Research*, **35**, 817–822.

Sabir, B. B., S. Wild, and J. Bai (2001) Metakaolin and calcined clays as pozzolans for concrete: a review. *Cement & Concrete Composites*, **23**, 441-454.

Sahmaran, M. (2006) The effect of chemical admixtures and mineral additives on the properties of self-compacting mortars. *Cement & Concrete Composites*, **28**, 432–440.

Sakai E., D. Atarashi, M. Daimon (2006) Interaction between superplasticiezrs and clay minerals. In: *Special publication ACI/6th CANMET conference on superplasticizers and other Chemical Admixtures*. Beijing Foreign Language Press, 1560-1566.

Santos, F. N., S. Raquel Gomes de Sousa, A. José Faria Bombard, and S. Lopes Vieira (2017) Rheological study of cement paste with metakaolin and/or limestone filler using Mixture Design of Experiments. *Construction and Building Materials*, **143**, 92–103.

Schneider, M., M. Romer, M. Tschudin, and H. Bolio (2011) Sustainable cement production — present and future. *Cement and Concrete Research*, **41**, 642–650.

Scrivener, K. L. (2014) Options for the future of cement. *The Indian Journal*, **88**, 11–21.

Sonebi, M., M. Lachemi, and K. M. A. Hossain (2013) Optimisation of rheological parameters and mechanical properties of superplasticised cement grouts containing metakaolin and viscosity modifying admixture. *Construction and Building Materials*, **38**, 126–138.

Spiratos, N., M. Page, N. P. mailvaganam, V. M. Malhotra, C. Jolicoeur (2006) *Superplasticizers for concrete fundamentals, technology and practice*. Handy Chemicals, Canada.

Svermova, L., M. Sonebi, and P. J. M. Bartos (2003) Influence of mix proportions on rheology of cement grouts containing limestone powder. *Cement & Concrete Composites*, **25**, 737–749.

Termkhajornkit, P. and T. Nawa (2004) The fluidity of fly ash-cement paste containing naphthalene sulfonate superplasticizer. *Cement and Concrete Research*, **34**, 1017–1024.

Tironi, A., A. N. Scian, E. F. Irassar, and C. Eng (2017) Blended Cements with Limestone Filler and Kaolinitic Calcined Clay: Filler and Pozzolan Effects. *Journal of Materials in Civil Engineering*, **29**, 1–8.

Tsivilis, S., E. Chaniotakis, E. Badogiannis, G. Pahoulas, and A. Ilias (1999) A study on the parameters affecting the properties of portland limestone cements. *Cement and Concrete Composites*, **21**, 107–116.

Tsivilis, S., E. Chaniotakis, G. Kakali, and G. Batis (2002) An analysis of the properties of Portland limestone cements and concrete. *Cement and Concrete Composites*, **24**, 371–378.

Uchikawa, H., S. Hanehara, and D. Sawaki (1997) The role of steric repulsive force in the dispersion of cement particles in fresh paste prepared with organic admixture. *Cement and Concrete Research*, **27**, 37–50.

Uchikawa, H., D. Sawaki, and S. Hanehara (1995) Influence of kind and added timing of organic admixture on the composition, structure and property of fresh cement paste. *Cement and Concrete Research*, **25**, 353–364.

Vance, K., M. Aguayo, T. Oey, G. Sant, and N. Neithalath (2013a) Hydration and strength development in ternary portland cement blends containing limestone and fly ash or metakaolin. *Cement and Concrete Composites*, **39**, 93–103.

Vance, K., A. Kumar, G. Sant, and N. Neithalath (2013b) The rheological properties of ternary binders containing portland cement, limestone, and metakaolin or fly ash. *Cement and Concrete Research*, **52**, 196–207.

Vance, K., G. Sant, and N. Neithalath (2015) The rheology of cementitious suspensions: A closer look at experimental parameters and property determination using common rheological models. *Cement and Concrete Composites*, **59**, 38–48.

Vikan, H. and H. Justnes (2007) Rheology of cementitious paste with silica fume or limestone. *Cement and Concrete Research*, **37**, 1512–1517.

World Business Council for Sustainable Development (WBCSD) and International agency (IEA), *Technology Roadmap, Low Carbon Technology for the Indian Cement Industry.* 2012.

Yahia, A. and K. H. Khayat (2001) Analytical models for estimating yield stress of high-performance pseudoplastic grout. *Cement and Concrete Research*, **31**, 731-738.

Yamada, K., S. Ogawa, and S. Hanehara (2001) Controlling of the adsorption and dispersing force of polycarboxylate-type superplasticizer by sulfate ion concentration in aqueous phase. *Cement and Concrete Research*, **31**, 375-383.

Yamada, K., T. Takahashi, S. Hanehara, and M. Matsuhisa (2000) Effects of the chemical structure on the properties of polycarboxylate-type superplasticizer. *Cement and Concrete Research*, **30**, 197–207.

Yilmaz, B. and A. Olgun (2008) Studies on cement and mortar containing low-calcium fly ash, limestone, and dolomitic limestone. *Cement and Concrete Composites*, **30**, 194–201.

Yip, C. K. and J. S. J. Van Deventer (2003) Microanalysis of calcium silicate hydrate gel formed within a geopolymeric binder. *Journal of Materials Science*, **8**, 3851–3860.

Yoshioka, K., E. I. Tazawa, K. Kawai, and T. Enohata (2002) Adsorption characteristics of superplasticizers on cement component minerals. *Cement and Concrete Research*, **32**, 1507–1513.

Yoshioka, K., E. Sakai, M. Daimon, A. Kitahara (1997) A role of steric hinderance in the performance of superplasticizers for concrete. *Journal of Ceramic Society*, **80**, 2667-2671.

Zaribaf, B. H., B. Uzal, and K. Kurtis (2015) Compatibility of Superplasticizers with Limestone-Metakaolin Blended Cementitious System. *Calcined Clays for Sustainable Concrete*, RILEM, 427–434.

Zhang, T., S. Shang, F. Yin, and A. Aishah (2001) Adsorptive behavior of surfactants on surface of Portland cement. *Cement and Concrete Research*, **31**, 1009–1015.

Zhang, Y. and X. Kong (2015) Correlations of the dispersing capability of NSF and PCE types of superplasticizer and their impacts on cement hydration with the adsorption in fresh cement pastes. *Cement and Concrete Research*, **69**, 1–9.

Zhang, Y., X. Kong, Z. Lu, Z. Lu, and S. Hou (2015) Effects of the charge characteristics of polycarboxylate superplasticizers on the adsorption and the retardation in cement pastes. *Cement and Concrete Research*, **67**, 184–196.

Zingg, A., F. Winnefeld, L. Holzer, J. Pakusch, S. Becker, R. Figi., and L. Gauckler (2009) Interaction of polycarboxylate-based superplasticizers with cements containing different C₃A amounts. *Cement and Concrete Composites*, **31**, 153–162.

Zingg, A., F. Winnefeld, L. Holzer, J. Pakusch, S. Becker and L. Gauckler (2008) Adsorption of polyelectrolytes and its influence on the rheolog, zeta potential, and microstructure of various cement and hydrate phases. *Journal of Colloid and Interface Science*, **323**, 301–312.